



Indigo

VENDOR MANUAL
FOR
INDIGO PRIVATE LABEL
VENDORS

VERSION 8.0

TABLE OF CONTENTS

INTRODUCTION	7
INDIGO VENDOR CODE OF CONDUCT	8
DIVERSITY, EQUITY & INCLUSION	12
INDIGO OPEN-DOOR POLICY	13
<u>SECTION 1 – VENDOR ONBOARDING</u>	14
VENDOR REGISTRATION	14
1.1 Indigo Vendor Agreement	15
1.2 Certificate of Insurance	15
1.2.1 Insurance Coverage Requirements.....	15
1.2.2 Insurance Requirements by Product Category	16
1.3 Social Compliance Program.....	17
1.3.1 Social Compliance Policy Statement.....	17
1.3.2 Vendor Code of Conduct.....	17
1.3.3 Social Compliance Audit	17
<u>SECTION 2- EDI EXPECTATIONS & ONBOARDING</u>	19
2.1 Introduction	19
2.2 E-Commerce Standards	19
2.3 Benefits of EDI	19
2.4 EDI Transaction Set.....	20
2.5 Indigo's EDI Service Provider.....	20
2.6 EDI Onboarding with Indigo	20
2.7 EDI Enabled Vendors – Testing & Certification.....	21
2.8 EDI Transmissions	21
2.9 GS1-128 Label	22
2.10 Vendor EDI Contacts.....	21
2.11 Indigo EDI Contacts	22
<u>SECTION 3 – ARTICLE SET-UP</u>	23

ARTICLE SET-UP: PIM (PRODUCT INFORMATION MANAGEMENT)	23
3.1 Benefits of PIM	24
3.2 Riversand PIM Vendor Registration.....	24
3.3 Product Data Quality	24
3.4 French Translation	25
3.5 Key Links & Contacts.....	26
3.6 Product Data Compliance	26
UPC (UNIVERSAL PRODUCT CODE) LABELS	28
<u>SECTION 4 – PURCHASE ORDERS & INVOICE PAYMENTS</u>	29
PURCHASE ORDER PROCESS	29
4.1 Purchase Order Detail.....	29
4.2 Purchase Order Dates.....	29
4.3 Purchase Order Line Items	30
4.4 Purchase Order Freight/INCO Terms	30
4.5 Purchase Order Acknowledgement (POA).....	31
4.6 Purchase Order Change Process	31
INVOICE PAYMENT & BILLINGS	32
4.7 Invoices.....	32
4.7.1 Invoice Payment	32
4.8 Billing for Compliance Chargebacks.....	32
4.8.1 Invoice & Billing Inquiries.....	33
<u>SECTION 5 – SAMPLE PROCESS & PRODUCT QUALITY</u>	34
SAMPLE PROCESS	34
5.1 Sample Tag.....	34
a. Development Sample.....	34
b. T.O.P. Sample.....	34
c. Media/Photo Sample.....	35
d. Pre-production Sample	35
5.2 Product Worksheet (PWS).	35

5.3 T.O.P. (Top Of Production) Samples	36
5.4 Delayed Samples Due to Customs Issues	36
5.5 Sample Courier Protocol & Process	36
5.6 Sample Approval Process	38
5.7 Sample Packaging & Labelling Guidelines	39
<u>SECTION 6 – PRODUCT COMPLIANCE AND QUALITY</u>	41
6.1 Product Quality Policies.....	41
6.1.1 Product Compliance Policy	41
6.1.2 Private Label Policy	41
6.1.3 Product Incident Management	41
6.1.4 Product Withdrawal or Recall.....	41
6.1.5 Bilingual Packaging and Labelling Requirements	42
6.2 Product Testing Procedures.....	42
6.2.1 Product Testing Request.....	42
6.2.2 Test Protocols	43
6.2.3 Transit Testing (Package Testing).....	43
6.2.4 Test Invoices and Payments	43
6.2.5 Pre-Shipment Inspection	44
6.3 Food/Gourmet Vendors – Additional Requirements.....	44
6.3.1 Indigo Allergen Checklist.....	44
6.3.2 Marketing Samples	44
6.3.3 Product Codes.....	44
6.3.4 Indigo Quality Assurance Samples For Review	45
6.3.5 Temperature Control.....	45
<u>SECTION 7 - SUPPLY CHAIN EXECUTION & VENDOR COMPLIANCE</u>	46
VENDOR PERFORMANCE MANAGEMENT PROGRAM (VPM).....	46
THE PERFECT ORDER GUIDELINE.....	46
7.1 On-Time Delivery/Shipment/ASN Delivery (“On Time”)	46
7.1.1 On-Time Shipment (OTS).....	46
7.1.2 On-Time Booking.....	47
7.1.3 On-Time Delivery (OTD) - to DC (Where Applicable)	48
7.1.4 On-Time ASN (Advance Shipping Notice).....	49

7.2	Fill Rate - (“Complete”)	49
7.3	Accurate Documentation (“Accurate”)	49
7.3.1	ASN Accuracy (EDI Vendors only)	50
7.3.2	Bill of Lading Accuracy	50
7.3.3	Packing Slip Accuracy	51
7.3.4	Invoice Accuracy	52
7.4	In Good Condition (Shipment Quality)	53
7.4.1	Case & Pallet Labelling Guideline	53
7.4.2	Master/Case & Pallet Labelling Requirements for EDI Vendors	53
7.4.3	Master/Case Labelling Requirements for Non-EDI Vendors	60
7.4.4	Inner Case/Pack Labelling Requirements (EDI & Non-EDI Vendors)	62
7.4.5	Labelling for Specialty Products- EDI & Non-EDI Vendors	63
7.4.6	Labelling Compliance To Canadian Laws & Regulations	63
7.5	Packing Guideline	65
7.5.1	Inner/Outer Case Pack Requirements	66
7.5.2	Carton Specific Packaging Requirements	66
7.5.3	Inner Packaging Material Requirements	68
7.5.4	Pallet Specific Packaging Requirements (where applicable)	69
7.5.5	Packaging for Specialty Products	71
7.5.6	Additional Packaging Requirements	72
7.5.7	Price Sticker Specification & Placement Guideline (for DC orders)	73
7.5.8	Damage-Free Shipment/Product	73
<u>SECTION 8 VENDOR COMPLIANCE PROGRAM</u>		74
Summary		74
8.1	Compliance Chargebacks	74
8.2	Measuring Non-Compliance & Notifications	80
8.3	Quarantine	80
8.4	Compliance Charge Dispute Process	80
<u>SECTION 9 – SHIPPING GUIDELINES</u>		82
9.1	Freight Terms & Responsibilities	83
9.2	Inbound Shipment Requirements	84
9.2.1	Packing Slip	84

9.2.2 Bill of Lading.....	85
9.2.3 International (Air & Sea) Transportation Document Requirements.....	86
9.2.4 Physical Presentation Requirments.....	86
9.3 Routing Instructions	86
9.4 Domestic Shipments Procedure	87
9.5 International Shipments Procedure & Additional Requirements.....	88
9.5.1 V. SOLAS Requirements & VGA Declaration.....	89
9.5.2 Original Customs Documents	90
9.5.3 Canadian Customs Clearance Document Requirements	91
9.5.4 Canada Customs Invoice/Commercial Invoice.....	93
9.5.5 From "A" Certificate of Origin	93
9.5.6 NAFTA	94
9.5.7 NAFTA Certificate of Origin.....	94
9.5.8 NAFTA Low Value Declaration	95
<u>SECTION 10 - CONTACTS</u>	96
<u>SECTION 11 - APPENDICES</u>	99



CHANGE LOG

Section	status	Guideline
Vendor Code of Conduct	updated	Indigo VENDOR CODE OF CONDUCT- updated with Cotton clause under Forced Labour
Diversity, Equity & Inclusion	new	Diversity, Equity & Inclusion
Indigo Open-Door Policy	new	Indigo Open-Door Hotline
Vendor Registration	updated	Changes to vendor registration process
1.1 Indigo Vendor Agreement	updated	Name change (formerly referred to as the Purchase Agreement)
1.3.2 Insurance Requirements by Product Category	updated	Updated requirements for liability insurance coverage by product category (see appendix for full list of required coverage by category)
1.4.3 Social Compliance Audit	updated	Updated list of Accepted Audits
Section 2 - EDI Expectations & Onboarding	updated	EDI Service Provider update, including introduction of InterTrade's ecCatalogue for product data; new table identifying EDI transactions & frequency expectations; updated EDI contacts
Section 3 - Article Set-up	updated	French Translation resource update Product Data Compliance
Section 4 - Purchase Order Process	updated	Updates to 4.5 POA and 4.6 PO Change Process sections
Section 5 – Sample Process & Product Quality	updated	Sample Tag updates; PWS update
5.5 – Sample Courier Protocol & Process	new to the manual	Updated info (newly included in the vendor manual)
5.6 – Sample Approval Process	new to the manual	(newly included in the vendor manual)
5.7 – Sample Packaging & Labelling Guidelines	new to the manual	(newly included in the vendor manual)
5.5 Product Compliance & Quality	updated	Updates to the section
7.5 Packing Guideline	updated	New references to Online DC packing requirements
8.4 Compliance Charge Dispute Process	updated	Updated process – all disputes to be initiated on the Compliance portal
Section 8 - Contacts	updated	Updates to Contacts
Section 9 - APPENDICES	updated	Updates to: <ul style="list-style-type: none"> • COI requirements matrix – by product type • Customs Tariff – Schedule: updated link provided

INTRODUCTION

Our goal at Indigo Books & Music Inc. is to delight our customers with a unique shopping experience while meeting the needs of our employees, shareholders and other stakeholders including our vendor community.

The purpose of this document is to communicate to our vendors Indigo's supply chain requirements in pursuit of this goal. We are committed to being a world class supply chain organization focused on delivering the right product to the right place at the right time at the right cost without defect. We want to have a mutually rewarding relationship with our vendors; this manual is designed to help both organizations realize this.

This document will guide you through Indigo's expectations for each of the following:

- Vendor Code of Conduct
- Vendor Set-up
- EDI Set-up
- Article/Product Data Set-up
- Purchase Orders
- Supply Chain Execution & Vendor Compliance
- Shipping Guidelines

We expect that the requirements contained in this document are communicated both within your organization and to your suppliers and sub-contractors that produce or provide materials or services used in the manufacture of goods sold to Indigo, to ensure that they too are in compliance, where applicable.

We believe our expectations are fair and support the goals of being mutually rewarding for each organization. We thank you in advance for doing your best to meet these expectations.

The most updated version of this Vendor Manual is also available at indigo.ca in the About Indigo/Vendors & Authors section.

INDIGO VENDOR CODE OF CONDUCT

Indigo Books & Music Inc. (together with its subsidiaries, "Indigo") is committed to doing business in a legal, ethical, socially responsible and sustainable manner. In turn, Indigo expects its suppliers, agents, service providers, and contractors (collectively, "Vendors") to embrace this commitment to integrity by complying with the standards detailed in this Vendor Code of Conduct (the "Code") and communicating these standards to their workers and suppliers. We insist that our Vendors and their suppliers uphold the highest ethical standards in their workplace, business practices, conduct and policies. In addition to adhering to this Code, Vendors must always comply and stay updated with local laws and regulations in each of the countries in which they do business. Where there is a differing standard between this Code and the local legal requirements, Vendors must comply with the higher standard.

This Code is based on the United Nations Universal Declaration of Human Rights, International Labor Organization Conventions and Recommendations and other internationally accepted standards.

GUIDING PRINCIPLES

Vendors' business and labour practices must comply with the laws and regulations of the countries in which they conduct business. Furthermore, Vendors must comply with the requirements of this Code, even when this Code exceeds the requirements of those applicable laws and regulations.

LABOUR PRACTICES

Child Labour

Indigo will not tolerate the use of child labour. Vendors, and any subcontractors they use, shall not employ in any of their facilities any person under 15 years of age. Where the minimum age for work or mandatory schooling is higher than 15 years of age by local law (where work is performed), such stipulated higher age applies in that locality. Workplace apprenticeship programs must comply with all applicable local laws and this Code. ILO Conventions 79, 182 apply.

Forced Labour

Vendors shall not engage in or support forced or compulsory labour, including slave, prison, trafficked, indentured, or bonded labour in any of their facilities or their subcontractor facilities. Workers must not be coerced to work (regular or overtime hours) by means of violence or intimidation, and must have sought work on their own free will and have the freedom to leave work or terminate their employment with reasonable notice. Neither the Vendor nor any entity supplying labour to the Vendor shall withhold any part of any personnel's salary, benefits, property or documents in order to force such personnel to

continue working for the organization. Workers must be given clear contracts in a language understood by the worker. ILO Conventions 29 and 105 apply.

Due to forced and underage labour in the Uzbekistan and Turkmenistan cotton regions, all vendors supplying cotton or products containing cotton ("Cotton Products") to Indigo must certify that any Cotton Products sold to Indigo do not contain and are not sourced from cotton that originates from the countries of Uzbekistan and Turkmenistan.

Discrimination/Human Rights

Vendors shall not engage in or support discrimination in hiring, remuneration, access to training, promotion, termination, discipline, retirement or any other term or condition of work (other than legitimate occupational requirements allowed by law) on the basis of race, colour, national or territorial or social origin, ethnic origin, citizenship, religion, faith, political opinion, gender, sexual orientation, age, marital status, same-sex partnership status, family status, disability, or any other condition that could give rise to discrimination. ILO Conventions 100, 111 and 156 apply.

Disciplinary Practices

Vendors shall treat all personnel with dignity and respect. Vendors shall not engage in or tolerate the use of corporal punishment or other forms of mental or physical coercion, or verbal abuse of their workers.

Harassment & Abuse

Vendor shall not abuse or harass workers, whether physical, psychological or sexual. No harsh or inhumane treatment will not be tolerated.

Wages and Benefits

Vendors must compensate all workers with wages, including overtime, that meet or exceed minimum legal standards in the countries in which they conduct business, or by their collective agreements, whichever is greater. The wage paid shall be sufficient to cover the basic needs of workers and their families. Illegal deductions from wages including deductions as a disciplinary measure are prohibited. Wages must be disbursed in a convenient and timely manner to workers with the detail of pay provided on a pay slip or similar documentation. Vendors must also provide all legally mandated benefits. ILO Conventions 26, 95 and 131 apply.

Working Hours

Vendors shall comply with the applicable local laws of working hours of the countries in which they conduct business, or with industry standards and relevant ILO conventions, whichever standards are more stringent. In either case, a worker's weekly hours must not exceed 48 hours or 60 hours with overtime, on a regular basis. Workers must be permitted to

receive at least one (1) day (24 hours) of rest following each six (6) consecutive days of work. Overtime must be voluntary and vendor must compensate workers for overtime at the legal premium rate. ILO Conventions 1 and 14 apply.

Freedom of Association/ Worker Representation

Vendor shall respect the right of workers to form or join at their own discretion an association or organization dedicated to protecting and promoting worker interests. Vendor shall not interfere with or inhibit the workers' pursuit of freedom of association and collective bargaining, where legally permitted. Where restricted by law, workers must be allowed to pursue parallel means to freely associate for bargaining purposes. Vendors must provide an open and anonymous communication channel for workers to report grievances. ILO Conventions 87, 98, 135, 154 apply.

HEALTH & SAFETY

Vendors shall provide a safe and healthy working environment in structurally sound buildings consistent with all applicable local building, fire, electrical and chemical safety laws and regulations. Vendors shall also protect workers by ensuring they are not exploited, nor exposed to dangerous, unsafe or hazardous conditions. Vendors shall adopt required measures and implement adequate systems to prevent, detect and avoid potential health and safety incidents and occupational injury or illness arising out of, associated with or occurring in the course of work. Vendors must guarantee that workers are provided regular training on health and safety requirements. Factories must provide good ventilation, access to clean drinking water, sufficient and clean toilets and washing facilities, first aid supplies, and personal protective equipment. Where housing or dormitories are provided for workers, they must be separate from production areas and must be kept safe, healthy and sanitary. ILO Convention 155 applies.

ENVIRONMENTAL PROTECTION

Vendors must comply with all applicable, local environmental laws and regulations, and shall commit to using practices to protect the environment by preventing contaminations due to hazardous materials or other dangerous substances resulting from production and operations within their facilities. Vendors shall maintain processes and standards for waste management, emissions, wastewater treatment, handling and disposing of chemical and hazardous substances, and for reporting any environmental accidents that may occur during operations.

ETHICAL CONDUCT

Vendors shall not engage in, or allow, any unethical practices such as fraud, bribery, corruption, or any matters that may pose a conflict of interest when dealing with Indigo or any worker, agent, public official, or an individual in the private sector. Vendors shall provide a mechanism or means by which workers may report anonymous workplace grievances and shall protect worker whistleblower confidentiality and prohibit retaliation.

SUB-CONTRACTING

Vendors must ensure that all permitted subcontractors comply with the requirements of this Code.

MANAGEMENT SYSTEMS

Vendors must develop and maintain management systems to implement, monitor and ensure compliance with this Code. This must include clear processes, policies, documentation, appointment of staff responsible for implementation, ongoing monitoring, and worker feedback and participation. In the event of any violation of the Code's requirements, Vendors must document and take prompt remedial action. Documentation and records must be maintained and be readily available upon request.

Indigo is committed to ensuring that our vendors and their suppliers uphold the highest ethical standards in workplace conditions and labour practices. Our sourcing policies are subject to change at any time in Indigo's sole discretion.



DIVERSITY, EQUITY & INCLUSION

Diversity, Equity and Inclusion are at the heart of what we do at Indigo, we are committed to providing an assortment that reflects the diversity of our society.

We have joined the **15% pledge** to ensure we partner intentionally with even more diverse vendors to bring our customers a joyful experience.

If you would like more information about our DEI initiatives, please contact diversity@indigo.ca

INDIGO OPEN-DOOR POLICY

At Indigo, we have a strong and long-standing commitment to doing the right thing, and we have zero tolerance for unethical conduct. In line with this commitment, we have set up the **Indigo Open Door Hotline** as outlined below.

If you wish to report unethical behavior or a possible violation of the Indigo Vendor Code of Conduct, you are encouraged to work with your primary Indigo contact in resolving your concern. If that is not possible or appropriate, please use the Indigo Open-Door Hotline.

The Indigo Open Door Hotline is available to external parties to confidentially communicate any Code of Conduct concerns or violations with respect to Indigo employees and the Vendors that Indigo conducts business with. Any person who believes that a violation of the Indigo Vendor Code of Conduct or Employee Code of Conduct has occurred is asked to report the incident in confidence as follows:

By phone: 1 (888) 881-3177 (North American toll free)

Or by visiting: www.IndigoOpenDoor.ca (North American & international submissions)

Please refer to the quick video link for an overview on how to make a submission online:

[Introducing Indigo Open Door](#)

Indigo will make every effort to investigate all reported violations in a discreet, fair and confidential manner, and will take appropriate action, as required, to maintain the integrity of its business.

SECTION 1- VENDOR ONBOARDING

VENDOR REGISTRATION

New vendors will be sent an invitation email to register on the **Indigo Vendor Hub** (onboarding portal). Vendors should be prepared to provide the required information on the **Registration Checklist** (below) prior to proceeding with registration.

Registration Checklist

Complete
 Incomplete

Vendor Agreement
 Registration Checklist
 General Business Information
 Company Code Information
 Business Address
 Country Specific Tax Information
 Banking Details
 Diversity, Equity and Inclusion
 Sustainability
 Certificate of Insurance
 Document Upload
 Review and Submit

Please be prepared to provide the following before you proceed with registration:

1. Company contact information
2. Tax Registration Information (TIN, HST, ID, VAT, GST, NIF as applicable)
3. Banking Information
4. Business classification
5. Diversity Equity & Inclusion Questionnaire
6. Document Upload

Thank you. For any questions, please contact helpdesk vendorsetup@indigo.ca

[Next >>](#) [Save Draft](#)

There are also additional reference documents that vendors should review to understand Indigo's complete supply chain requirements – these can be found on the Indigo Vendor Hub in the **Help** section by selecting **Vendor Documents**:

- **Vendor Manual** (this document)
- **Packing Guidelines – Online, Retail & Drop Ship**
- **Drop Ship Vendor Guide (for Drop Ship vendors only)**
- **Introduction to Indigo's PIM (Product Information Management) System**
- **EDI at Indigo Overview**
- **Preparing Your First Shipment to Indigo (checklist)**

Private Brand vendors will also be required to submit a valid **Social Compliance Audit** for each factory where the sourced product is being manufactured; this may also apply to some National Brand vendors, as required (please refer to the **Social Compliance Program** section for further detail on audit requirements).

We have provided an **Indigo Vendor Hub - Vendor Guide** document in the **Help** section of the portal that provides detailed instructions on how to complete the registration on the portal.

Please forward any additional inquiries regarding our onboarding requirements to VendorSetup@indigo.ca

1.1. INDIGO VENDOR AGREEMENT

The Vendor Agreement sets forth the standard terms and conditions applicable to the purchase of products ordered by Indigo from vendor from time to time. Please refer to Indigo's Vendor Agreement to review in full detail.

The Vendor Agreement is a digital, click through agreement that is found at the start of the registration process.

1.2. CERTIFICATE OF INSURANCE

1.2.1. INSURANCE COVERAGE REQUIREMENTS

Indigo requires vendors to have and maintain comprehensive general liability insurance coverage, at vendors cost, that meet the following requirements:

- a. Insurance Coverage.** Comprehensive commercial general liability insurance with minimum limits of coverage of not less than the amount set out in the Vendor Insurance Matrix (see Appendix) per occurrence for bodily injury and property damage which must include the following coverages: personal injury liability, bodily injury liability, advertising injury liability, products and completed operations liability, blanket contractual liability (including liability for damage to or losses relating to performance by Vendor of its obligations to Indigo), and property damage liability (including liability for damage to or losses relating to an Indigo location and any Indigo or other third party chattels, property, merchandise, trade fixtures, or monies), and business interruption relating to Indigo's operations.
- b. Occurrence Basis.** All coverage required by Indigo must be written on an occurrence basis. Claims-made policies are not acceptable.
- c. Additional Insured.** Vendor's insurance **must designate Indigo Books & Music Inc. as an Additional (or Joint) insured**, including with respect to third party claims or actions brought directly against Indigo or against Indigo and Vendor as co-defendants.
- d. Currency:** Vendor insurance may be provided in CAD or the vendor's home currency, provided the respective coverage is the equivalent of the total CAD amount that is required.

- e. **Severability of Interests;** Subrogation. Vendor's coverage must provide for a severability of interests between Indigo and Vendor, and all policies of insurance shall contain an endorsement waiving all rights of subrogation against Indigo.
- f. **Supplier Insurance is Primary.** Vendor's insurance will be primary and will be required to respond to and pay prior to any other available coverage of Indigo.
- g. **Self-Insurance.** Indigo does not allow Vendors to self-insure their coverage requirements, without Indigo's prior written consent.
- h. **Cancellation.** Indigo requires and expects that either Vendor or its insurer/broker will provide Indigo with at least thirty (30) days advance written notice of any material change or cancellation of the applicable policies.
- i. **Certificate of Insurance.** Vendors must provide a valid certificate of insurance that:
 - Clearly specifies the required coverage(s) (type(s) & amount(s));
 - List Indigo as an additional insured;
 - Describes Vendor's business and/or the products being supplied to Indigo;
 - Includes Vendor's address; and
 - References Indigo's address:

Indigo Books & Music Inc.
620 King Street West, Suite 400
Toronto, Ontario
M5V 1M6

Certificates of Insurance **must be renewed annually**, and an uploaded on the Indigo Vendor Hub.

1.2.2. INSURANCE REQUIREMENTS BY PRODUCT CATEGORY

Indigo requires vendors to maintain the required liability insurance coverage by product category. The coverage requirements are categorized by **\$1M, \$2M, \$5M and \$10M insurance limit amounts**. **Please refer to the Vendor Insurance Matrix in the [Appendix](#) section for a complete/detailed product category list to understand your respective insurance requirements.**

Please note that additional liability insurance coverage limits may be required for new/specialty products and new/special product categories at any given time. These will be added to the respective limit category and communicated to the respective vendors as required.

1.3. SOCIAL COMPLIANCE PROGRAM

1.3.1. SOCIAL COMPLIANCE POLICY STATEMENT

Our Code of Conduct is the foundation of our social compliance program and will serve as a guide to achieving social and environmental compliance both within our company and in our supply chain. While we recognize that laws and standards may differ from one region of the world to another, we believe that our Code of Conduct outlines a set of fundamental principles for good corporate citizenship that our business partners should share and implement.

The social compliance program will direct business partners towards greater compliance with local and international legal requirements and help them maintain good standing for continued business with Indigo. Business partners who do not continually meet our standards or complete corrective actions and steps for long-term remediation will not be considered a business partner of choice and are at jeopardy to the discontinuation of conducting business with Indigo.

1.3.2. VENDOR CODE OF CONDUCT

Indigo Books & Music Inc. (together with its subsidiaries, "Indigo") is committed to doing business in a legal, ethical, socially responsible, and sustainable manner. In turn, Indigo expects its vendors to embrace this commitment to integrity by complying with the standards detailed in this Vendor Code of Conduct (the "Code") and communicating these standards to their workers and suppliers. We insist that our Vendors and their suppliers uphold the highest ethical standards in their workplace, business practices, conduct and policies. In addition to adhering to this Code, Vendors must always comply and stay updated with local laws and regulations in each of the countries in which they do business. Where there is a differing standard between this Code and the local legal requirements, Vendors must comply with the higher standard.

This Code is based on the United Nations Universal Declaration of Human Rights, International Labor Organization Conventions and Recommendations and other internationally accepted standards.

(Please refer to the Indigo Code of conduct section at the beginning of this document)

1.3.3. SOCIAL COMPLIANCE AUDIT

Vendors manufacturing Indigo Private Label product are required to produce a valid social compliance audit that demonstrates the factory's adherence to Indigo's Social Compliance Program and Vendor Code of Conduct. Indigo may also request a social compliance audit by National Brand vendors, as needed. The vendor will be responsible for the cost of any audits or

any other associated activity needed to implement corrective actions to remediate failures. Factories, at a minimum, must undergo an annual social compliance audit.

Use of external accredited audit firm is required to provide an assurance of objectivity. External Audit Firms should be part of the Association of Professional Social Compliance Auditors (APSCA) members. The auditor must be registered with APSCA.

Accepted Audits

- OMEGA Compliance Supplier Audit/ICTI Ethical Toy Program Certification (ICTI CARE)
- BSCI (Business Social Compliance Initiative) Audit
- Sedex Members Ethical Trade Audit (SMETA)
- Bureau Veritas Audit (BV)
- Intertek Audit
- SGS Audit

Corrective Action

We embrace the principle of continuous improvement. We believe that willingness to improve is the most important requirement. If issues arise during the assessment, Indigo will expect its Vendors to remediate them in accordance with the jointly agreed upon **corrective action plan (CAPs)** and corresponding timeframes.

We want to partner only with those factories that are willing and able to continuously improve conditions for their workers. Serious violations of Indigo's Code of Conduct shall result in the termination of the business relationship.

SECTION 2 - EDI EXPECTATIONS & ONBOARDING

2.1. INTRODUCTION

This is intended to set the Electronic Data Interchange (EDI) expectations Indigo Books & Music Inc. has of you as a trading partner. Please ensure that you review all sections and share this with anyone in your company that may need this information.

Vendors must provide Indigo with at least five (5) business days advance written notice of all Vendor system changes and modifications that could have an adverse effect on Vendor-Indigo communications of Orders, including Vendor's EDI connectivity. Vendors will be deemed to have received any Indigo communications if Vendor fails to provide the required notice of a system change.

2.2. E-COMMERCE STANDARDS

Indigo expects that all vendors will transact via EDI from the initial onset of our commercial relationship. There are significant productivity and process visibility gains that are realized through the use of EDI. Exemptions to this requirement may be granted by Vendor Compliance based on the following criteria:

- Timing of initial order: temporary exemption (applicable to initial PO only; given EDI onboarding has been initiated and is in progress)
- Anticipated size of ongoing relationship expected to be **less than \$75K/year of annual purchases**: permanent exemption

Please note that the cost of **EDI non-compliance** is \$150 per non-EDI Purchase Order.

2.3. BENEFITS OF EDI

- Enhanced order visibility from PO to Invoice
- Accelerated time to market
- Faster order to cash cycle
- Improved data integrity & inventory management (reduce errors)
- Increased automation/eliminate manual processes
- Unlock Drop Ship capability

2.4. EDI TRANSACTION SET

Indigo believes that the ability to conduct business electronically on these and future documents is critical to operating effectively with your firm. The documents currently required are:

- 850 Purchase Order (PO)
- 855 Purchase Order Acknowledgment (POA)
- 856 Advance Ship Notice (ASN)
- 860 Purchase Order Change (POC)
- 810 Invoice
- 846 Inventory Inquiry (for **Drop Ship vendors only**)
- 997 Functional Acknowledgement
- GS1-128 Label

2.5. INDIGO'S EDI SERVICE PROVIDER

Indigo has partnered with InterTrade to manage the transition of our vendors to EDI with Indigo Books & Music. Vendors can access program information including EDI specifications on InterTrade's Indigo EDI vendor portal.

To access the portal as a generic user, and view Indigo's specifications, please go to:

<https://InterTrade.com/Indigo/>

For GM EDI specs, please go to "Indigo Books & Music Inc. - General Merchandising"

2.6. EDI ONBOARDING WITH INDIGO

As part of your onboarding with Indigo, a representative from InterTrade will contact you to initiate the EDI onboarding process. Vendors can choose one of the following EDI fulfilment solutions:

- **Integrated EDI solution** (to connect via 3rd party provider or in-house EDI); this will require testing and certification with InterTrade; **to register for EDI certification**, select "EDI Testing and Certification", fill in information and submit.
- **InterTrade's WebEDI solution** (Indigo's preferred web EDI solution for trading partners); this is a cloud-based option available to vendors with no existing EDI solution; **to register for WEB EDI**, select "Register for Web EDI", fill in information and submit.

Please ensure you identify your preferred solution to Indigo's EDI Team at EDISupport@indigo.ca

2.7. EDI ENABLED VENDORS – TESTING & CERTIFICATION WITH INTERTRADE

As an existing vendor transacting via EDI with Indigo Books & Music Inc., you will be expected to interact with InterTrade as existing EDI documents are changed and/or new EDI documents implemented. You will be notified of any such developments and InterTrade will work directly with your organization to Test & Certify the new documents as required.

If you are currently using a third-party EDI provider, you are not required to change to InterTrade services; however, your provider will be required to Test & Certify through InterTrade on new Indigo Books & Music Inc. documents.

If you are migrating to a new EDI service provider, please advise support@intertrade.com and EDISupport@indigo.ca prior to making this change, with sufficient advanced notice. It is important to consider whether there are open orders residing with your current EDI service provider; you will need to ensure that return document flow for any such open orders is managed without interruption by your new EDI service provider. This process can take 2-3 weeks to be executed properly.

2.8. EDI TRANSMISSIONS

EDI transactions will flow daily as follows: (note: these are based on hours of operation)

EDI Transaction	Data	Direction	Frequency
EDI 850	Purchase Order	From InterTrade	Daily , as required
EDI 855	Purchase Order Acknowledgement	To Intertrade	Within 1-2 business day of receiving the 850 PO (excluding weekends & holidays)
EDI 860 (not required for Drop Ship)	Purchase Order Change (POC)	From InterTrade	Daily , as required
EDI 856	ASN	To Intertrade	Daily , immediately following shipment of an order
EDI 810	Invoice	To Intertrade	Along with ASN
EDI 997	Functional Acknowledgment	Bi-directional	Immediately sent by the respective recipient system following each EDI document transmission

2.9. GS1-128 LABEL

GS1-128 label format is available through InterTrade. Alternatively, an approved example of a GS1-128 label can be found in the Label Guidelines section of this Manual.

A GS1-128 Barcode label must be applied to each carton and/or pallet shipped (based on shipping method); linking the individual carton/pallet to the associated ASN Item/Qty detail, as set forth in the Label Guideline section of this Guide.

Failure to meet Indigo's GS1-128 Label guideline requirements will cause your shipment to be quarantined within Indigo's Distribution Centres or Stores. A compliance chargeback will also be applied to any violation of this guideline (please refer to **Vendor Compliance Program** section for further detail).

2.10. VENDOR EDI CONTACTS

It is important for vendors to maintain/update their respective EDI contacts as both Indigo and InterTrade use these contacts for notification of any EDI document failures, issues, downtime/maintenance notifications or changes to Indigo's EDI requirements, program, etc... If the EDI contact person for your company changes, please send the details regarding this new contact to both support@intertrade.com and EDISupport@indigo.ca immediately.

2.11. INDIGO EDI CONTACTS

INTERTRADE (EDI SERVICE PROVIDER)

- **For immediate assistance**, please contact:
InterTrade Customer Support
1-800-873-7803
(8:30am – 8:00pm EST, Monday through Friday, excluding holidays)

For non-urgent assistance, please send an email to the following address with your name, your company name, and a detailed description of the issue:
support@intertrade.com

INDIGO EDI SUPPORT

- **Indigo EDI Support Team**
EDISupport@indigo.ca

SECTION 3 - ARTICLE SET-UP

ARTICLE SET-UP: PIM (PRODUCT INFORMATION MANAGEMENT)

Where required, some IPL vendors, as identified by Indigo, **may be required** to manage their article master data creation and changes. To assist them with this task, Indigo has provided a web-based application called **Indigo PIM ("PIM")** to manage article master data creation and changes for our online and retail sales channels. It is our expectation that vendors will submit **ALL article master data through our PIM system**. We realize that this application will be new for your organization, and so, we advise you to review the respective training materials that will be provided for you, and to direct any respective questions to PIM@indigo.ca

Indigo PIM provides the ability to load and maintain all aspects of article data 24 hours a day through a standardized interface that contains workflows to streamline and simplify all aspects of Indigo's article loading process.

PIM allows you to:

- Create new articles by providing all mandatory **article attributes** (as identified in the training documents and PIM system);
- Upload Single Article Data or Bulk Article Data (using Excel based templates);
- Upload multiple images to enhance your item;
- View the status of an article;
- Search for and modify existing articles and images;
- Track details of all the modifications that have been made to your articles.

Compatible Browsers:

Browser	Supported Versions	Certified versions
Google Chrome	Latest version of Chrome*	78.0.3904.70#
Mozilla Firefox	Latest version of Firefox*	70.0
Safari on Mac	Latest version of Safari*	12.1

Notes:

- *As long as there is no breaking change in the browser engine.
- #Google Chrome version has enhanced security features and due to which certain file types such as .xism and .json when downloaded, display a warning message. In order to consume the file, warning message must be ignored.
- Also note, for the best view of web elements in the application, a minimum screen resolution of 1024*768 is required.

3.1. BENEFITS OF PIM:

- Enhances product data management, workflow and accuracy;
- Enriches product descriptions (attributes, categories, content, images, media, etc...)
- Improves customer experience by providing relevant and detailed product information;
- Reduces operational and supply chain costs and risks due to poor product data;
- Improves system integration;
- Increases speed of transactional processes, from purchase order to goods receipt, through to the sale of the product.

3.2. RIVERSAND PIM VENDOR REGISTRATION:

Once you have been assigned a vendor number by Indigo, the following will occur:

- An Indigo PIM account will be created by Indigo's Master Data team;
- Vendors will receive an e-mail notification with instructions for login and password creation.
- Note: login USER NAME will be the e-mail address submitted by the vendor to be set-up as the data contact for PIM (as indicated on Indigo's Vendor Registration Form).
- Vendors will also be sent training information/access and materials, outlining the PIM article creation and maintenance process.
- Please note: PIM is for article submission only. Category Managers must approve your articles and images for Indigo usage.

If you have any questions, please contact PIM@indigo.ca and a member of Indigo's Master Data team will be in contact within 1 business day. We request that you do not forward questions regarding PIM functionality to Indigo merchants.

3.3. PRODUCT DATA QUALITY:

Key documents:

1. **Training Documents:** these documents include steps on how to create and manage articles/display units in PIM.

Link: please access these at **Learning Centre/PIM Training & Documents** on the Compliance Portal (<https://Indigo.TraverseSystems.com>)

2. **Data Dictionary:** please refer to this document for a list of article attributes:

Link: please access these at **Learning Centre/PIM Training & Documents** on the Compliance Portal (<https://Indigo.TraverseSystems.com>)

3. **Data Entry Guide:** please refer to this document for instruction on how to effectively enter article data:

Link: please access these at **Learning Centre/PIM Training & Documents** on the Compliance Portal (<https://Indigo.TraverseSystems.com>)

4. **Indigo Product Style Guide:** please refer to this document for more information on **product image guidelines** and **product copy guidelines**:

Link: please access these at **Learning Centre/PIM Training & Documents** on our Compliance Portal (<https://Indigo.TraverseSystems.com>)

5. **Writing Guide for French Products:** please refer to this document for guidelines on **use of proper French language** for product names and descriptions (required for all online and OMNI channel SKUs)

Link: please access these at **Learning Centre/PIM Training & Documents** on the Compliance Portal (<https://Indigo.TraverseSystems.com>)

3.4. FRENCH TRANSLATION

For vendors who are required to manage their article master data creation, they are expected to provide complete and quality French descriptions for all articles a **minimum of 10 business days before the expected in-DC date** (i.e. PO delivery date).

For vendors requiring a **French translation resource**, please reach out to either of Indigo's preferred partners (3rd party translation service provider):

TRANSPERFECT:

Website: www.transperfect.com

Email: Indigo@transperfect.com

Phone: 416-703-0050

TRSB:

www.trsb.com

Email: TRSB-Traductions@trsb.com

Phone: (514) 844-4682

To access **TRSB's customized services for Indigo vendors**, please submit your translation request via the designated portal <https://Indigo.TRSB.com/> (select country and create your account by clicking on sign-up; then enter **registration code: 552021**)

Please contact this partner directly for translation services and mention that you are an Indigo vendor. Please note: **translation service costs are the vendor's responsibility**.

Alternatively, if vendors are unable to provide French content, Indigo will complete the translation for the respective vendors and **will charge the total fee of the translation service** (charged by the 3rd party translation service provider) **in addition to** the **Missing Item Description (French) chargeback fee** (per UPC) to the respective vendor (see data compliance table below).

French language requirements:

To further clarify what we consider proper French and to comply with our naming structure, please see the **Scoring Table** and the **Writing Guide for French Products**.

SCORING TABLE

Here is the scoring table that we would also like to send to the vendor (you will also find that table in the auditing template, in the second tab).

Great	Text flows very well No errors (spelling, grammar, syntax, translation, language) Idiomatic French
Good	Non-localized French Some sentences could be formulated better Readability is good
Fair	Spelling: Fewer than 3 typos or error English terms more accepted (cool, fun, etc.) Punctuation errors
Bad	Machine translated or similar quality (unreadable) Translation errors (incorrect transfer) Spelling errors Syntax errors Grammar errors Language errors (Anglicism, wrong term)
No French	No FR whatsoever FR title and EN description EN title and FR description

3.5. KEY LINKS & CONTACTS

- **PIM Training & Documents:** Please refer to **Learning Centre/PIM Training & Documents** on the Compliance Portal (<https://Indigo.TraverseSystems.com>)
- Contact info:
 - For PIM related inquiries: PIM@indigo.ca

3.6. PRODUCT DATA COMPLIANCE

For vendors who are required to manage their article master data creation, the below list of **Product Data compliance rules** and respective **chargeback** amounts may apply:

Product Data Compliance	Rule	Charge Amount
Consumer Package Dimension Error		\$50 per UPC, per violation
Consumer Package Weight Error		\$50 per UPC, per violation
Master Case Dimension Error		\$50 per UPC, per violation
Master Case Weight Error		\$50 per UPC, per violation
Missing Product Image		\$100 per UPC
Poor Image Quality	Images must meet aspect ratio and resolution requirements/standards	\$50 per UPC, per poor aspect ratio or resolution
Missing Product Description - English		\$50 per UPC
Missing Product Description - French		\$50 per UPC
Insufficient Product Description Length - English	Product description (English) must meet minimum 25-word count requirement	\$50 per UPC
Insufficient Product Description Length - French	Product description (French) must meet minimum 25-word count requirement	\$50 per UPC
Inaccurate/Incorrect Product Description - French	Product description (French) must be accurate/correct as per Indigo's French standard requirements	\$50 per UPC

UPC (UNIVERSAL PRODUCT CODE) & PRICE STICKER LABELS

UNIVERSAL PRODUCT CODE ("UPC")

- Vendors are responsible for ensuring that the unique scannable UPC or EAN (International Article Number; formerly European Article Number) is provided on the unit. UPCs and EANs must meet the specifications defined by the Electronic Commerce Council of Canada.
- If possible, UPC numbers should never be reassigned; however, in the event one must be reassigned, Indigo requires that the number not be in use for a minimum of 36 months prior to reuse or reassignment to allow the UPC to pass through the retail product cycle.

PRICE STICKER LABELLING

- Vendors are responsible for pre-ticketing all units with Canadian retail price and scannable UPC (if not printed directly on the product or package).
- Vendors are responsible for ordering price stickers in a timely manner that will not delay shipment. Unless otherwise instructed by the responsible Indigo Product Manager or Indigo buyer, price sticker costs must be included in the cost of goods.
- Price stickers should be ordered from Indigo's designated vendor, Avery Dennison.
- Stickers should be placed on the back of the purple Indigo hangtag, or at the bottom or on the back of the packaging. Any price sticker placement questions should be directed to the responsible Indigo buyer.
- Please note that price stickers cannot cover any warning labels or care instructions.
- For further detail, please contact your respective Product Manager in the New York office.

SECTION 4 – PURCHASE ORDERS & INVOICE PAYMENTS

PURCHASE ORDER PROCESS

4.1. PURCHASE ORDER DETAIL

Indigo's Purchase Order will specify the following:

- Indigo Books & Music Inc. Purchase Order number. This is a 10-digit number beginning with the numbers 45 (i.e. 4512345678)
- Purchase Order Creation Date
- 'Ship To' and 'Bill To' locations (including Building #, Store #, SAN#)
- 13-digit case UPC code (being ordered)
- Item Description
- Vendor Manufacturing Part Number (if provided to Indigo)
- Listing Pack Size for outer and inner cartons (if applicable)
- Quantity (being ordered)
- Retail price in Canadian currency (for price sticker)
- Unit Costs in currency of record for vendor
- Delivery Date at the Ship To address
- Carrier Hand-over Date (CHO Date) (if applicable)
- INCO and FOB terms
- Payment Terms
- Method of Transportation

The following are the SAN numbers per Distribution Centre already in operational use, as follows:

DC Location	SAN#	Order Type
Retail DC (956)	1186213	Regular (Initial Buy & Replenishment)
Online DC (970)	1187414	Regular (Initial Buy & Replenishment)
Calgary DC (988)	8100608	Regular (Initial Buy & Replenishment)

If there are questions regarding the meaning of these data elements, please contact vendorcompliance@indigo.ca

4.2. PURCHASE ORDER DATES

For Collect orders, Vendor must **hand over** the items on the Purchase Order in full on the **CHO Date (Carrier Handover Date)** indicated on the Purchase Order.

4.3. PURCHASE ORDER LINE ITEMS

- Product ordered as part of one Purchase Order cannot be received against a different Purchase Order.
- Indigo will place a Purchase Order for the **UPC on the product**; vendor generated/internal SKU numbers will not be used on Indigo Purchase Orders when placing an order.
- Vendor should not ship “substitute” or “replacement” UPCs. In this case, the current PO line must be cancelled via Purchase Order Acknowledgment or by using the Purchase Order Change Form and a new PO line must be created for the new UPC. This must be confirmed/approved by the respective Indigo buyer.
- The Purchase Order quantity will be in “eaches” of product/UPC ordered (corresponding to individual units or assortment units).
- For assortments, Indigo will always order with the parent UPC.
- Indigo does not currently support the use of GTIN 14 product identifiers.
- It is imperative the UPC on the Purchase Order is what is shipped and is on the ASN. If the UPC is incorrect, please contact the Category Manager to have this corrected immediately upon receipt of the order. An incorrect UPC can only be addressed by cancelling the line item on the Purchase Order (see Purchase Order Change Process section below).

4.4. PURCHASE ORDER FREIGHT/INCO TERMS

Each Indigo Purchase Order specifies one of the following freight (INCO) terms:

- **EXW** – (ExWorks): Vendor is responsible for having order ready and available in full to be handed over (collected) at the vendor premises (factory, warehouse, plant, ...) within the agreed upon Ship Window (based on CHO date). Buyer pays all transportation costs and bears the risks for transporting the goods to its final destination (DC, Store).
- **FOB** – (Free on Board): Vendor is responsible for having order ready and available in full to be handed over within the agreed upon Ship Window (based on CHO date) at the agreed upon shipping location (FOB point), as specified on the Purchase Order.
- **FCA** – (Free Carrier): Vendor is responsible for delivering order in full, cleared for export, to the Buyer's designated freight forwarder (carrier), at an agreed upon, named location, within agreed upon Ship Window. Vendor must load shipment onto the Buyer's carrier. A receipt document from carrier to exporting vendor confirms transfer of shipment.
- **CIF** – (Cost, Insurance and Freight): This applies to maritime transport only. Vendor is responsible for paying the freight, insurance and other costs to deliver order in full to the

port of destination within agreed upon Ship Window. Once the shipment is loaded on the vessel, risk is transferred to the Buyer.

4.5. PURCHASE ORDER ACKNOWLEDGEMENT (POA)

For **non-EDI** vendors, the terms and details of the Purchase Order must be confirmed as follows:

- Vendor must review all terms of the Purchase Order and communicate any discrepancies to the respective Indigo contact **within three (3) business days** (i.e. incorrect UPC, cost, pack size, quantity, CHO date, INCO terms, etc...)
- If an adjustment is required, vendor must communicate this via e-mail correspondence acknowledging the change(s), from the Indigo buyer, before filling/shipping the order.
- If vendor does not communicate any discrepancies/required changes within the allotted 3 business days, the terms and order information on the original Purchase Order govern. A compliance chargeback may be applied to late and/or incomplete orders.
- Vendor must immediately notify the respective Indigo buyer of any changes to Purchase Order terms that may arise at a later date, including any foreseen late shipments.

For vendors **transacting via EDI**, the **POA** is an electronic document (EDI 855) that is used to confirm the terms and details of the Purchase Order:

- We require the **POA to be sent within three (3) business days** of receiving the Purchase Order.
- If your POA is rejected due to an error, the POA must be retransmitted once the error has been corrected.
- If we do not receive a valid POA, we will base delivery performance (on-time delivery, fill rate, etc...) on our original Purchase Order terms. A compliance chargeback may be applied to late and/or incomplete orders.

4.6. PURCHASE ORDER CHANGE PROCESS

For any required changes to a Purchase Order after the POA has been sent, or for vendors who are unable to send a POA but require changes to the PO, the following **PO Change process** must be followed:

- Vendor must review all terms of the Purchase Order and communicate any required changes using the **Purchase Order Change Request Form** (i.e. UPC, cost, case pack size, quantity, Delivery or CHO date, INCO terms, etc...).
- If an adjustment is required, vendor must await the receipt of a Purchase Order Change Notice (EDI 860), or an e-mail correspondence acknowledging the change(s), from the Indigo buyer, before filling/shipping the order.

- If vendor does not communicate any discrepancies/required changes to a Purchase Order up to 5 business days ahead of Delivery/CHO due date, the terms and order information on the original Purchase Order govern.
- Vendor must immediately notify the respective Indigo Buyer of any changes to Purchase Order terms that may arise at any time using this PO Change process, including any foreseen late shipments and/or quantity discrepancies.

INVOICE PAYMENT & BILLINGS

4.7. INVOICES

EDI vendors: Invoices are received via the 810 EDI document only. Any invoices sent via email by EDI vendors will not be processed for payment. .

Non-EDI vendors are the only exception; these vendors may send paper invoices, or preferably, a PDF version of the invoice by e-mail to the respective A/P contact at Indigo.

4.7.1. INVOICE PAYMENT

Indigo has two payment cycles per month: mid-month and month-end. The below examples illustrate when an invoice gets paid based on the terms of payment:

- Any invoice which is due for payment from the first of the month to the 15th will be paid on the 15th of the month;
- Any invoice which is due from the 16th of the month will be paid on the month end cheque run.
- Please note that invoices are aged from the date of the invoice, and are due for payment based on the terms of payment.

Important notes:

- Any discrepancy between the vendor invoice and our receiving data may result in a payment different than the value shown on the invoice (i.e. short shipment will result in short payment).
- Where an initial Purchase Order is cancelled by Indigo and a new Purchase Order No. is provided, the invoice must quote the new Purchase Order No.

4.8. BILLING FOR COMPLIANCE CHARGEBACKS

Where your organization has incurred compliance chargebacks as a result of non-compliant shipments, all amounts owing will be billed through the Indigo Debit Note Process.

4.8.1. INVOICE & BILLING INQUIRIES:

All inquiries regarding invoice and payment status should be directed to Indigo's Accounts Payable Department (Please refer to **Contact Information** section)

SECTION 5 – SAMPLE PROCESS & PRODUCT QUALITY

SAMPLE PROCESS

5.1. SAMPLE TAG

All samples must be marked with a sample tag as per below. Please note the colour code indicator based on Development, TOP, Media/Photo, and Pre-Production samples.

]

a. Development Sample (colour = blue)

Indigo Books & Music Inc. Sample		
Development sample	PD SEASON#	Description
Color		
Country		
Vendor		
Date		
Price		
MOQ		
Material		
Comment		
Indigo receipt Date		

b. TOP Sample (colour = orange)

Indigo Books & Music Inc. Sample		
TOP SAMPLE	PD SEASON#	Description
Color		
Country		
Vendor		
Date		
Price		
Actual units ordered		
Material		
Comment		
CHO Date		
Approval Date		
Approval Signature		

c. Media/Photo Sample (colour = yellow)

Indigo Books & Music Inc. Sample		
MEDIA SAMPLE	PD SEASON #	Description
Color		
Country		
Vendor		
Date		
Price		
MOQ		
Material		
Comment		
Indigo receipt Date		

d. Pre-Production Sample (colour = green)

Indigo Books & Music Inc. Sample		
PP SAMPLE	PD SEASON#	Description
Color		
Country		
Vendor		
Date		
Price		
Actual units ordered		
Material		
Comment		
CHO Date		
Approval Signature		

5.2. PRODUCT WORKSHEET (PWS)

In order to accurately assess freight costs, all vendors must fill in a product worksheet (PWS) when quoting pricing. All fields listed on the **Product Worksheet** form must be filled out at the time of price quote. (Please refer to the sample Product Worksheet excerpt below). Upon confirmation from the Sourcing Team, the final PWS will be required to be uploaded to the PIM system.

Product Worksheet (PWS) excerpt

Product Worksheet - Cost Breakdown													
Vendor #:		Vendor Name:		COG:									
Updated on:													
		AUTOCALCULATED: DO NOT COMPLETE		Vendor Article Name						Vendor Cost Price			
Plate	Vendor Length Unit # (if Applicable)	Vendor Item	FOB	UPC	FIM Barcode	Brand	Brand	Brand	Description	Primary Color	Color	FOB Cost	FOB Cost Net Including Rebates etc.

5.3. TOP (TOP-OF-PRODUCTION) SAMPLES

Indigo must receive **at least one** TOP sample of each item on order. All TOPs must have final brand packaging and price/UPC stickers. Protective packaging is not necessary on TOP samples. **Product cannot ship without a TOP sample approval by Indigo's Sourcing Manager/Team.**

At least one TOP sample must be sent to Indigo home office:

- **Indigo Home Office**
Attn: Sourcing Manager
 620 King Street West
 Suite 400
 Toronto ON, M5V 1M6

Please note that alternative protocols may become in effect when circumstances deem necessary

5.4. DELAYED SAMPLES DUE TO CUSTOMS ISSUES

For any product that is delayed due to customs issues, please contact your respective Indigo Sourcing Manager/Team contact.

5.5. SAMPLE COURIER PROTOCOL & PROCESS

- All design, production and market samples are to ship in separate Master Cartons to:

Indigo
620 King Street West, Suite 400
Toronto, ON
Canada M5V 1M6
Tel# (416) 364-4499

- **Package Confirmation Emails Required:**

- E-mail subject heading should include the season/year and the courier tracking number. The body of the e-mail should list the sent items. If the package contains items that cross over different seasons, a separate e-mail must be sent with the subject heading showing the different season and same courier tracking number.
- Example: FA20 PP Samples sending 1/2/2021 via FedEx 7793 6163 4924
- Kiyomi Ruvalcaba is to be copied on all DVS/PP sample package confirmation emails

- **Design samples (DVS):**

- All design samples are to be sent to the attention of Kiyomi Ruvalcaba (see attached design shipping label)
- Each design prototype in the master carton must be individually labeled with the name of the recipient/category designer, Category (i.e. JOTT, Home, ROHO, Journals, Wellness) and Season. (Please see following Indigo Packages guidelines.

- **Designers:**

- ROHO Sleepwear/Fashion Accessories: Lorrain Chow (lchow@indigo.ca)
- Wellness/ Fitness Bags/ Self Care & Beauty: Lorrain Chow (lchow@indigo.ca)
- Hard Home/JOTT, Coffee + Tea: Ange-line Tetrault (atetrault@indigo.ca)
- Soft Home/JOTT: Zayd Khan (zkhan@indigo.ca)
- Bedding/Bath: Sarah Lowry (slowry@indigo.ca)
- Desktop/Wellness (Yoga/Fitness): Tatum Dietrich (tdietrich@indigo.ca)
- Journals: Ann Kim (a.kim@indigo.ca)
- Expression Mugs: Maura Garcia (mgarcia@indigo.ca)

- **Sourcing and Production Samples:**

- All Pre-production (PP) are to be sent to the attention of Kiyomi Ruvalcaba
- All Top-of-Production (TOP) samples are to be sent to the attention of the respective sourcing manager

- Each design prototype in the master carton must be individually labeled with the name of the recipient/category designer, Category (i.e. JOTT, Home, ROHO, Journals) and Season. (Please see Attached Indigo Packages guidelines.)
- **Sourcing Production Managers**
 - ROHO & Wellness – Arlene Ing (aing@indigo.ca)
 - JOTT & Home – Kate Chan (kchan1@indigo.ca)
 - Journals, Desktop, Kids - Arlene Ing (aing@indigo.ca)
- **Packaging Samples:**
 - There is no change to process. Please continue to send to the attention of Ann Kim.
- **Media Samples:**
 - There is no change to process. Please continue to send to merchants, and ensure that all Media samples are sent with the correct packaging. Media samples should reflect the approved PP sample and not sent before PP has been approved.

5.6. SAMPLE APPROVAL PROCESS

- **Design Team:**
 - Owns the development and all communication of DVS/ design samples until the Tech pack is completed and item purchased and moved to production stage.
 - Owns receipt and management of Preproduction (PP) samples.
- **Design:**
 - Owns the final sign-off of Preproduction samples. Design will send PP approval comments (cc sourcing) to vendors.
 - Sourcing is responsible for troubleshooting any production issues.
- **Sourcing:**
 - Owns TOP sign-off and communication to vendor. If the TOP has variances from the PP sample approved, Merchant decides whether to accept the item or not, and looping in the Design team.
- **Design Packaging:**
 - All Design Packaging questions should be addressed to: Ann Kim (AKim@indigo.ca) with a copy to the respective sourcing manager

5.7. SAMPLE PACKAGING & LABELLING GUIDELINES

Indigo Packages Guidelines



Master Carton Label ←

Inner Packages Label →

Note: Inner packages do not have to be a separate carton (as the image), can be polybags.

1- Design Samples DVS / Design Prototype - Ship to:

To: **Indigo**
 620 King Street West - Suite 400,
 Toronto ON
 M5V 1M6

Attention:
 Design Department / Kiyomi Ruvalcaba

To: **Indigo**

Recipient: _____
 Category: _____
 Season: _____

2- Production Samples PP & TOP's - Ship to:

PP SAMPLES

To: **Indigo**
 620 King Street West - Suite 400,
 Toronto ON
 M5V 1M6

Attention: Kiyomi Ruvalcaba

TOP SAMPLES

To: **Indigo**
 620 King Street West - Suite 400,
 Toronto ON
 M5V 1M6

Attention: Sourcing Department/*indicate the Sourcing Manager's name*

Note: All samples must be tagged with corresponding label i.e.

DVS

PP

TOP

Email to be sent - Subject Heading Example
 FA20 PP Samples - Sending on 1/2 via Fedex 7793 6163 4924

Master Carton Label for Design (DVS & PP samples)

To: **Indigo**

620 King Street West - Suite 400,
 Toronto ON
 M5V 1M6

Attention:
 Design Department / Kiyomi Ruvalcaba

Master Carton Label for Sourcing (TOP samples)

To : **!ndigo**

620 King Street West - Suite 400,
Toronto ON
M5V 1M6

Attention: Sourcing Department/**Indicate the
Sourcing Manager's name**

Inner Carton Label

To : **!ndigo**

Recipient:

Category:

Season:



SECTION 6 - PRODUCT COMPLIANCE AND QUALITY

6.1. PRODUCT QUALITY POLICIES

6.1.1. PRODUCT COMPLIANCE POLICY

At Indigo Books & Music Inc. we provide our customers with safe and high integrity products that complies with applicable laws, regulations, and industry standards of the countries we operate in. This includes all applicable and required government registrations, licenses, testing and certifications. Upon request, all vendors are expected to have supporting documentation that confirms products being supplied have met all applicable regulations and standards of the countries where we conduct business. Non-Compliance to applicable regulations may result in the cancellation of purchase orders and/or products withdrawals and recalls.

6.1.2. PRIVATE LABEL POLICY

It is the expectation that all Indigo private label product shall meet regulatory requirements and Indigo's performance expectations, which will be outlined in Indigo's QA protocol. Indigo branded products are subjected to 3rd party audits, testing and inspection at the discretion of Indigo's product quality team.

6.1.3. PRODUCT INCIDENT MANAGEMENT

Consumer Product Safety is governed in Canada by the Canada Consumer Product Safety Act (CCPSA) and in the U.S by the Consumer Product Safety Commission (CPSC), with some exclusion: Cosmetics, Foods, Drugs, Medical Devices and Natural Health Products. Vendors are required to comply with the requirements of these acts, including participating with Indigo in investigating Consumer Product Incidents relating to personal injury or property damaged.

If a recall or withdrawal is initiated by the vendor or is requested or required by any governmental authority, vendors shall promptly advise Indigo of such recall or withdrawal.

Vendor shall notify Indigo's Category Manager and Quality Assurance, within two (2) calendar days of becoming aware of any possible non-compliance with product laws, or its notice of a claim from a consumer (which, individually or in the aggregate, may reasonably be expected to result in material liability to vendor and/or Indigo) that a product is defective or does not comply with all product laws.

6.1.4. PRODUCT WITHDRAWAL OR RECALL

In the event of a regulatory recall or alert of a product safety risk, Indigo reserves the right to issue a recall notice, cancel outstanding purchase orders and return all product for a full refund and charge back the vendor any costs incurred to facilitate the recall/withdrawal.

6.1.5. BILINGUAL PACKAGING AND LABELLING REQUIREMENTS

All Consumer Packaging and Labelling, whether is Indigo private label or national brand, must be bilingual (English and French) and in compliance with Canada's Consumer Packaging and Labeling Act and Quebec's Charter of French Language. All information on the product, on its container or on its packaging, on a document (i.e. instruction manual) or object supplied with it must be in French and English. No inscription in another language may be given greater prominence than that in French.

6.2. PRODUCT TESTING PROCEDURES

Indigo private label Vendors are fully responsible for all testing of production merchandise to guarantee that products pass testing and meet the current Bureau Veritas testing protocol. The product quality and safety of Indigo products, all vendors are required to provide:

- third-party test reports to demonstrate that the goods being supplied to Indigo meets all applicable Canadian and U.S. requirements and performance requirements according to Indigo's test protocols, and
- pre-shipment inspection report showing that the goods pass inspection, before the goods can be shipped to Indigo.

6.2.1. PRODUCT TESTING REQUEST

- Vendors shall arrange product testing directly with an accredited third-party service provider once the QA test plans have been received from the product quality team.
 - Testing shall be conducted according to the test plans and to the Indigo test protocols assigned.
 - Product specifications (where applicable) and mock-up artwork labels (if actual packaging/labels are not available) shall be submitted along with the samples to the lab for dimensions/claim validation.
- Test report must be submitted to and approved by Indigo QA before proceeding to next steps.
- Vendors must allow for sufficient time for testing. If a product is not submitted with sufficient time for testing and order is delayed, vendor is responsible for late charges.

NOTE: In-house test reports are not acceptable. Vendors may have product testing conducted by any one of our nominated third-party labs – Bureau Veritas, Intertek or SGS, however Indigo's QA team must be copied on the test report to ensure timely approval.

Claim Validation

For qualitative claims that cannot be evaluated at the lab where no analytical method is available for evaluation (e.g. organic claims, source of fibers), vendors are required to provide supportive documentation to Indigo QA for review and approval prior to PO issuance.

6.2.2. TEST PROTOCOLS

A set of test protocols has been developed exclusively for Indigo by Bureau Veritas ("BV"). All protocols are posted on BV's Docushare website and are made available to Vendors by accessing the following link:

<https://docushare.CPS.bureauveritas.com/docushare/DSWEB/Login>

Username: **vendor@indigo**

Password: **color0531**

(Please note: Username and Password are case-sensitive, spaces should not be entered before or after the text.)

If a protocol does not exist for a specific product type, please allow 3 (three) weeks lead time for the protocol to be developed. Alternatively, Indigo may approve testing using a non-Indigo protocol provided by BV.

6.2.3. TRANSIT TESTING (PACKAGE TESTING)

Vendors may have transit testing (cartons packed for shipping) conducted by an accredited service provider using ISTA-1A standards or perform in-house testing to the same standards (refer to the Appendix, Drop Test Requirements in the manual).

6.2.4. TEST INVOICES AND PAYMENTS

- **Vendors are responsible for all testing charges.**
- Vendor is responsible for all invoice, and for paying the service provider directly for the cost of testing. A vendor contact should be indicated in the "Invoice Recipient" field of the Test Request Form.
- FOB Pricing is to be inclusive of all testing charges.

6.2.5. PRE-SHIPMENT INSPECTION

- Vendors shall arrange pre-shipment inspection directly with a nominated third-party service provider only after receiving Indigo's approval on test results and production is 100% complete.
- Inspection report must be submitted to and approved by Indigo QA prior to shipment. Indigo uses General Inspection Level II AQL 2.5 Major; all finished goods must be 100% produced and at least 80% packed prior to inspection, unless otherwise stated by Indigo.
- Vendors must allow for sufficient time to schedule for pre-shipment inspection and obtain a "pass" grading. If the inspection/re-inspection cannot be completed in-time and the order is delayed, vendor is responsible for late charges.

6.3. FOOD/GOURMET VENDORS - ADDITIONAL REQUIREMENTS

6.3.1. INDIGO ALLERGEN CHECKLIST

The Indigo Allergen Checklist (see Appendix) must be completed by the manufacturing facility and submitted to Indigo Quality Assurance (QA) prior to shipment of goods, for review against final product artwork/label.

6.3.2. MARKETING SAMPLES

Indigo's Food/Gourmet Category Managers will contact Food/Gourmet vendors regarding marketing sample requirements.

6.3.3. PRODUCT CODES

- Indigo requires that each salable unit of food be identified with a code mark in the form of a Best Before Date ("BBD") on the label or container. Coding is mandatory to trace products through the distribution chain and to facilitate recalls.
- An example of the Canadian Food Inspection Agency ("CFIA") Best Before Date format is shown in the table below.
- The term 'Best Before' must be shown in English and French (Best before / Meilleur avant).
- The year must appear first, followed by the month, then the day. This format is used to avoid confusion in date interpretation.

- The month must appear in both official languages by using specified bilingual Month symbols, as shown below.

Shelf Life	Code Date Type Required	CFIA Format
All shelf lives, including 90 days or less	Use "Best Before Date" NOT "Expiry Date"	Best before 08 JA 30 Meilleur avant

Month	Bilingual Month Symbols to be used in Code
January:	JA
February:	FE
March:	MR
April:	AL
May:	MA
June:	JN
July:	JL
August:	AU
September:	SE
October:	OC
November:	NO
December:	DE

- If BBD codes are applied by sticker, the adhesiveness must be validated to withstand handling, to ensure traceability of the code.

6.3.1. SHELF LIFE

Products arriving at

Indigo's DCs and/or Store locations must have 80% of their shelf life (minimum 90 days) remaining at time of receipt.

6.3.4. INDIGO QUALITY ASSURANCE SAMPLES FOR REVIEW

- Two final production samples from the manufacturing facility are required by Indigo QA for QA Release prior to shipment of goods.
- Send samples to **Indigo Home Office** to the attention of "**QA – Product Sample for QA Release**"

620 King St. West
Suite 400
Toronto ON, M5V 1M6

6.3.5. TEMPERATURE CONTROL

Chocolate confectionery temperature control in transit to DCs and/or Store locations is to be arranged where required.

SECTION 7 - SUPPLY CHAIN EXECUTION & VENDOR COMPLIANCE

VENDOR PERFORMANCE MANAGEMENT PROGRAM (VPM)

Indigo is committed to having a world class supply chain organization focused on delivering the right product to the right place at the right time at the right cost without defect. To help achieve this, Indigo's Vendor Performance Management (VPM) program communicates our supply chain performance guidelines to our vendors and measures their compliance against those guidelines. This program is intended to initiate collaborative efforts between Indigo and its vendor community to improve operational efficiencies, product quality, and the overall customer experience.

THE PERFECT ORDER GUIDELINE

Indigo's **Perfect Order Guideline** applies to all product purchased for resale by Indigo Books & Music Inc. inbound to each of our DC and store locations. This guideline plays a key role in ensuring that our vendors are delivering orders **on-time, complete, with accurate** documentation, and **in good condition**, in support of our supply chain productivity goals.

The Perfect Order Guideline includes Indigo's performance expectations for:

- On-Time Shipment/ASN
- Fill Rate ("complete" order)
- Accurate Shipment Documentation
- Shipment Quality ("in good condition")

7.1. ON-TIME DELIVERY/ SHIPMENT/ BOOKING/ ASN DELIVERY ("ON TIME")

7.1.1. ON-TIME SHIPMENT (OTS)

a. Applicable to: Vendors that have the following INCOTERMS*:

- EXW
- FOB

- FCA
- CIF

(* please refer to the INCOTERM table in our **Shipping Guidelines** for a summary of Buyer/Seller responsibilities)

b. Guideline:

- Indigo expects Purchase Order shipments to be ready and available in full to be handed over within the Ship Window.
- The Ship Window is defined as follows:
 - **For Ocean/Air (outside of North America):** up to ten (10) business days early, and three (3) business days late compared to the final acknowledged/agreed to Purchase Order Carrier-Hand-Over Date (CHO Date).
 - **For Land (inside of North America):** up to three (3) business days early, and three (3) business days late compared to the final acknowledged/agreed to Purchase Order CHO Date.
- A shipment handed over outside the Ship Window will be considered as non-compliant and will be subject to a Late/Early Shipment chargeback.
 - **Rescheduling CHO Date:** a CHO Date revision request must be submitted by using the **PO Change Form** up to 5 business days ahead of the current PO CHO Due Date; change requests may or may not be approved, at the discretion of the Merchant/Buyer:
 - If CHO Date revision is approved, OTS performance will be measured against the revised CHO Date, referred to as the "final agreed to" CHO Date;
 - If CHO Date revision is not approved, or if the PO Change Request is submitted outside the permitted window indicated above, OTS performance will be measured against the original CHO Date on the Purchase Order.

7.1.2. ON-TIME BOOKING

- A completed Freight Notification Form (please refer to Appendix Section) must be sent to Indigo's international Freight Forwarder & Customs Broker ("Carrier") as follows:
 - **Ocean shipment:** min. 2 weeks in advance of the CHO date.

- **Air shipment:** min. 2 weeks in advance of the CHO date (outside of North America)
- **Truck shipment:** min. 3 business days in advance of the CHO date (within North America)
- It is recommended that vendors book as early as possible, but at a minimum based on the deadlines indicated above.
- Upon receipt of the Freight Notification Form, Indigo's 3PL Provider will provide Routing Instructions to the vendor.
- Bookings made outside the above timelines will be subject to a Late Booking chargeback.

7.1.3. ON-TIME DELIVERY (OTD) - TO DC (WHERE APPLICABLE)

a. **Applicable only to:** vendors that have the following INCOTERMS:

- DDP
- DAP

b. Guideline:

- Indigo expects Purchase Orders to be delivered on-time and in full to the correct DC location (DC Delivery) or Store location (DSD - Direct Ship Delivery) within Delivery Window.
- The **Delivery Window** is defined as up to three (3) business days early, and three (3) business days late compared to final acknowledged/agreed to Purchase Order Delivery Date.
- An order delivered outside the Delivery Window will be considered as non-compliant, and will be subject to a Late/Early Delivery chargeback.
- Rescheduling Delivery Date: a Delivery Date revision request must be submitted by using the **PO Change Form** up to 5 business days ahead of the current PO Delivery Due Date; change requests may or may not be approved, at the discretion of the Merchant/Buyer:
 - If Delivery Date revision is approved, OTD performance will be measured against the revised Delivery Date, referred to as the "final agreed to" Delivery Date;
 - If Delivery Date revision is not approved, OTD performance will be measured against the original Delivery Date on the Purchase Order.

7.1.4. ON-TIME ASN (ADVANCE SHIPPING NOTICE)

The ASN is an electronic document (EDI 856) that is used to describe the actual contents of a shipment.

- Indigo expects EDI vendors to send a valid EDI 856 (ASN) **immediately after the shipment departs from the vendor's facility**; this will allow time for remedial action to be taken in the event of ASN failure.
- It is critical to ensure your ASN is loaded into our Warehouse Management System prior to your shipment arriving at the DCs or Store locations, otherwise, it could result in rejection or receiving delays.
- An **ASN delivery** is considered late and non-compliant if it is not received and processed successfully before delivery of the physical shipment at the respective DC or Store location(s). **For Drop Ship orders**, an ASN is considered late and non-compliant if it is not sent 2 business days after PO issue/sent date.
- A compliance chargeback may be applied to late/missing/inaccurate ASNs.

7.2. FILL RATE - ("COMPLETE")

- Indigo expects our Purchase Order Lines to be shipped/delivered complete, that is, 100% filled, on the initial shipment; and for the overall PO to be shipped/delivered 100% complete 60 days after the expected PO CHO/Delivery Date.
- A variance of +/- 5% of the Purchase Order line order quantity will be tolerated; however, the following results will be considered as non-compliant:
 - A shortage: shipped quantity variance is less than -5%
 - An overage: shipped quantity variance is greater than +5%
 - Wrong/Substitute product shipped
 - **If the item comes in various colors and sizes, there cannot be more than 2% in an individual color or size.**
- A Purchase Order line with a non-compliant Fill Rate may be subject to a Fill Rate chargeback for short shipment, over shipment or PO not filled.

7.3. ACCURATE DOCUMENTATION ("ACCURATE")

- Indigo expects all documentation & EDI transactions preceding, accompanying, and succeeding an inbound shipment to be accurate and complete, matching exactly the details of the respective Purchase Order(s), and ship-to location.

- Such documentation includes:
 - Valid EDI 856 (ASN) (EDI vendors only)
 - Bill of Lading
 - Packing Slip
 - Invoice
 - Customs Documentation
- Any of the above documentation that is non-compliant with the requirements below may be subject to the respective compliance chargeback.

7.3.1. ASN ACCURACY (EDI VENDORS ONLY)

- Indigo expects (EDI) vendors to send a timely, valid and accurate EDI 856 (ASN) whose details exactly match what has been routed for shipment.
- An ASN is considered to be **inaccurate and non-compliant if does not meet our EDI 856 specifications** (specifically all mandatory segments/requirements). Please refer to Indigo's 856 EDI Specifications for more detail.
- An ASN is considered to be **invalid and non-compliant if** there is a:
 - systemic error/failure
 - receiving data error/failure
- If your ASN is rejected due to an error, the ASN can be retransmitted with the same ASN number once the error has been corrected.
- An invalid or inaccurate ASN may be subject to an ASN Error chargeback.

7.3.2. BILL OF LADING ACCURACY

- Indigo expects all vendor shipments to be accompanied by an accurate Bill of Lading whose details exactly match what has been routed for shipment.
- The Bill of Lading must include at a minimum:
 - The full name and address of Shipper
 - Name of Carrier
 - Consignee:

Indigo Books & Music Inc.

Correct Indigo DC/Store ship-to address

- Accurate BOL No. (same as on respective ASN)
 - Shipment Details:
 - No. of pallets (if applicable)
 - No. of cases/cartons
 - Total Weight shipped
 - Purchase Order No.(s)
 - Ship Date
 - Description of Items Shipped & QTY
 - Wood packaging declaration
 - Indication of products that require special handling or stowage.
 - Indication of food products that require temperature control and/or put-away within a given time.
- For EDI shipments, it is mandatory that the Bill of Lading # (BOL) associated with your shipment be included in the ASN. Failure to provide the BOL # could lead to your shipment being rejected at our Distribution Centre Appointment Desk.
 - If the actual BOL # is not available at the time of the ASN creation, please do the following:
 - Enter Indigo's Purchase Order No. beginning with "45" in the BOL # field for the ASN;
 - Ensure that Indigo's Purchase Order No. is noted clearly on the carrier's shipping documentation that will be presented to Indigo's Distribution Centre Appointment Desk. This will allow them to locate your ASN within Indigo's warehouse management system and provide the carrier a dock door to unload your shipment.
 - A Bill of Lading is considered to be inaccurate and non-compliant if there is an error with/ or is missing any of the above required details.
 - An inaccurate or missing BOL may be subject to the respective compliance chargeback.

7.3.3. PACKING SLIP ACCURACY

- Indigo expects all vendor shipments to be accompanied by an accurate Packing Slip whose details exactly match what has been routed for shipment.
- The Packing Slip must contain, at a minimum:

- Purchase Order No.(s)
 - Date of Shipment
 - Ship-to Location/Address (Destination)
 - List of UPCs
 - List of Product Descriptions
 - Total units shipped by Description and total quantity back-ordered
 - List of correct lot numbers (if applicable)
 - For international shipments: Number of cartons per SKU/per PO at the container level when shipping multiple containers under one MBL
- The Packing Slip should be easily identified **on the outside of the shipment**.
 - A Packing Slip is considered to be inaccurate and non-compliant if it does not meet any of the above requirements.

7.3.4. INVOICE ACCURACY

- Indigo expects EDI vendors to send a valid and accurate Invoice (EDI 810 document) whose details match the respective Purchase Order details for the exact item(s) and quantity(s) that have been shipped.
- Non-EDI vendors are expected to include the following Purchase Order details on their paper invoices. The Invoice must accurately contain:
 - Invoice No.
 - Invoice Date
 - Vendor's DUNS #
 - Purchase Order No.(s)
 - Date of shipment
 - Accurate payment terms
 - Payment currency
 - List of UPCs shipped (this **must match** the UPC that is ordered on the PO)
 - List of Product Descriptions shipped
 - Quantity Shipped by Item (in eaches) by UPCs
 - Accurate Unit Price (per each) of UPCs shipped

- Detailed list of other applicable charges & unit/total price per charge
 - Accurate invoice sub-total
 - Accurate calculation of total applicable taxes & duties
 - Accurate calculation of total all other applicable charges
 - Accurate grand total calculation
- An Invoice is considered to be inaccurate and non-compliant if it does not meet any of the above requirements.
 - An inaccurate Invoice may be subject to the respective compliance chargeback.

7.4. IN GOOD CONDITION (SHIPMENT QUALITY)

7.4.1. CASE & PALLET LABELING GUIDELINE

Indigo's **Case & Pallet Labeling Guideline** applies to all inbound product that has been purchased for resale by Indigo Books & Music. This guideline plays a key role in ensuring that vendors provide the label requirements for shipment to our DC and Store locations in the manner expected to support our supply chain productivity goals.

Definitions:

Master/Outer Case/Pack: a vendor's outermost carton containing the ordered units, packed loosely or in inner packs.

Inner Case/Pack: packaging material (i.e. inner carton, polybag, ...) grouping together a number of ordered units within a master/outer pack.

7.4.2. MASTER/OUTER CASE & PALLET LABELING REQUIREMENTS FOR **EDI VENDORS**

Indigo expects that the majority of our vendors are transacting via EDI. This section applies to all vendors transacting via EDI.

General Label Requirements (EDI shipments)

A labeling violation will occur if a label is missing, inaccurate or unscannable. Reasons why a label would be identified as missing, inaccurate or unscannable include:

- GS1-128 label is missing
- Invalid SSCC-18 code used for Handling Unit Number
- Invalid characters (presence of symbols or alpha characters)

- Duplicate barcodes (duplicate barcodes will not be accepted)
- Photocopy (photocopies of labels taped to cases will not scan correctly)
- Poor print quality which causes the label to not scan correctly
- Defaced and/or partially missing label
- Barcode and human readable are different (barcode must de-code to the human readable number printed on the label)
- Barcode is too big (bleeds to edge of label) or too small
- Tape over label (including "clear" tape)
- PO #, UPC, Carton QTY not indicated on the label
- Incorrect item UPC and/or carton QTY indicated on label
- Incorrect Ship-to included on the label
- Carton weight is missing

Outer Case (Master Carton) Label Requirements for EDI Vendors Sending Case/Pack Level ASNs

Each Outer Case must contain an EDI GS1-128 Label in accordance with GS1 Global Standards. Indigo's label requirements follow standard GS1/EAN SSCC-18 common label formats. Detailed information about the SSCC-18 data structure and associated GS1/EAN-128 symbol can be found online at <http://www.gs1ca.org/home.asp>.

Indigo GS1 - 128 Label Zones

The label is formatted into several information zones (see below). Zones include both human readable information and GS1/EAN-128 information. Each zone contains a zone title and information pertaining to that zone. Please see the illustration and zone explanations below.

Illustration not to scale
Actual size = 4"x6" conforming to GS1 standards

Zone A

Ship From:

Ship From Name
Address 1
Address 2
City, State Postal Code

Zone B

Ship To:

Ship To Name
Address 1
Address 2
City, State Postal Code

Zone C

Carrier:
B/L Number:
PO:
UPC:
Carton Qty:

(420) Ship To Postal Code

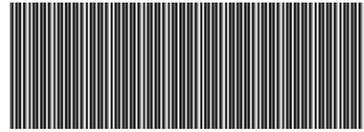

(420) 85263

Zone D

Zone E

Final Destination Store:

(91) 956

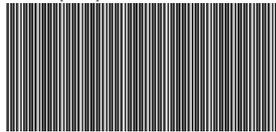

Final Destination:

Final Destination Name
Address 1
Address 2
City, State Postal Code

Zone F

Zone G

Serialized Shipping Container Number

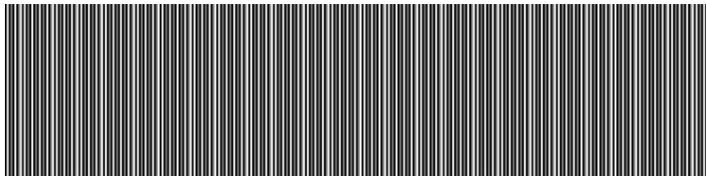

(00) 0 125385 012345678 9

Zone

A	Vendors ship from name and address is required	10 to 12 pt font
B	Ship to name and address is required	10 to 12 pt font
C	Shipment Information -Carrier is required - B/L # is required if available; however, it must be provided in EDI 856 - PO Number is required - UPC is required - Carton Qty (total # of units in the carton) is required	10 to 16 pt font
D	Ship To postal code and barcode (optional)	10 to 16 pt font
E	Final Destination Store Number and bar code (for Cross-Dock shipments only; if DC shipment, indicate DC #)	10 to 16 pt font
F	Final Destination Name and Address (for Cross-Dock shipments only; leave blank for DC shipments)	10 to 16 pt font
G	UCC-128 Serial Shipping Container Code (SSCC-18) is required Packaging Type indicator (3 rd digit): <ul style="list-style-type: none"> • "0" for case/carton • "1" for pallet 	20 mil bars

Cross Dock Label Requirements (where applicable)

Indigo's labeling requirements for cross-dock shipments are slightly modified from the GSI-128 Label Zone Example provided above. The Final Destination Name and Address in Zone F must also include the Indigo DC Dock Spot that corresponds to this Final Destination Name & Address.

*Illustration not to scale
Actual size = 4"x6"

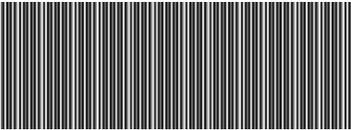
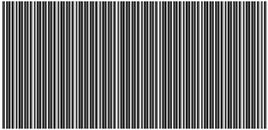
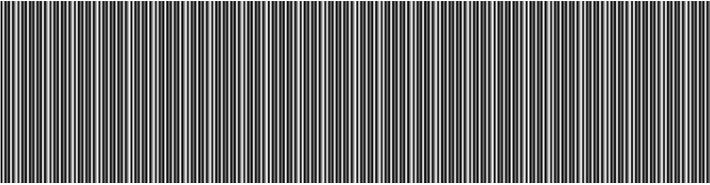
Zone A	Ship From: Ship From Name Address 1 Address 2 City, State Postal Code		
Zone B	Ship To: Ship To Name Address 1 Address 2 City, State Postal Code		
Zone C	Carrier: B/L Number: PO: UPC: Carton Qty:	(420) Ship To Postal Code  (420) 85263	Zone D
Zone E	Final Destination SAN #: (92) 1186213 	Final Destination: Final Destination Name Address 1 Address 2 City, State Postal Code Dock Spot (Actual 3 Digit Number XXX)	Zone F
Zone G	Serialized Shipping Container Number  (00) 0 125385 012345678 9		

Zone Content

A	Vendors ship from name and address <u>is required</u>	10 to 12 pt font
B	Ship to name and address <u>is required</u>	10 to 12 pt font
C	Shipment Information -Carrier <u>is required</u> - B/L # is required if available - PO Number <u>is required</u> - UPC is required if available -Carton Qty required	10 to 16 pt font
D	Ship To postal code and barcode	10 to 16 pt font
E	Final Destination SAN #	10 to 16 pt font
F	Final Destination Name and Address; Dock Spot (Actual 3 Digit Number XXX) based on the store's X-Dock number provided by Indigo.	10 to 16 pt font
G	UCC-128 Serial Shipping Container Code (SSCC-18) is required Packaging Type indicator (3rd digit): • "0" for case/carton • "1" for pallet	20 mil bars

Label Placement

- The GS1-128 label must be placed on the shortest side of the outer case on the right hand side;
- Labels must all be placed under shrink wrap (not overtop), but the barcode on the label must be scannable;
- Barcodes must be printed in vertical bar configuration;
- Placement of the label must be such that the bottom edge of the barcode containing the SSCC-18 is located at least 1.25 inches from the bottom of the outer case (shipping container);
- The outermost bar of the barcode cannot be closer than 1.25 inches from the vertical edge of the outer case (shipping container);
- If unable to have the barcode containing the SSCC-18 at least 1.25 inch from any edge of the outer case (shipping container), then place the GS1-128 carton label on "top" of the outer case (shipping container);
- Outer cases should only contain one unique GS1-128 label. All additional "internal" barcodes on the outer case must be marked out or covered as this is in conflict with the barcode on the GS1 -128 shipping label.

Pallet Label Requirements for EDI Vendors Sending Pallet Level ASNs (for Retail DC only)- IF APPLICABLE

These requirements only apply if a vendor is providing Indigo a shipment that contains a pallet level ASN. There are significant productivity improvements that Indigo and the vendor can realize from using this ASN structure. **Please note that Pallet/Tare Level ASNs are NOT SUPPORTED at our Western DC location (pack level only)**

The label requirements are as follows:

For full or half-pallet shipments of a single product (i.e. single UPC):

- Vendor provides a single **Pallet Level ASN (SOTI structure)** rather than a case level ASN (SOPI structure). This allows Indigo to receive the entire product on the pallet with one scan of the pallet label rather than with multiple scans of each case on the pallet.
- **Only a pallet HU GS1-128 label is required; individual carton HU GS1-128 labels are not required.** The pallet label must be placed on the top carton on the right hand side, under the shrink wrap (not overtop), but the barcode on the label must be scannable.
- **The UPC and description of the respective product and the total quantity of units must be marked/indicated on each individual master carton on the shipment.**
- Two half-pallet shipments may be placed on one skid if separated by a slip sheet and/or a pallet (hence creating layers), with a pallet HU GS1-128 label per layer/shipment.
- Pallet shipments must be packed to a maximum pallet height of 52 inches, and one case pack size only.
- Alternatively, vendors may provide a SUPER-PACK SOPI ASN using the existing SOPI ASN structure, essentially creating one big carton for the total quantity of units on the pallet:
 - this option requires only a pallet HU GS1-128 label;
 - individual carton HU GS1-128 labels are not required (*only item UPC and QTY must be indicated on the carton);
 - Please note that for this option: the Packaging Code in the TD1 segment must indicate "PLT" (not "CTN"), and the Lading Quantity must indicate the total # of pallets.
- Please note that only one structure type (SOPI or SOTI) can be used per ASN, that is, one ASN cannot contain both SOPI and SOTI structure types.)

Package Type Indicator - Case vs. Pallet Label

As indicated in **Zone G of Indigo GS1- 128 Label Zones**); the 3rd digit of the SSCC code indicates the unit level packaging type (i.e. case/carton vs. pallet) as follows:

- "0" for carton
- "1" for pallet

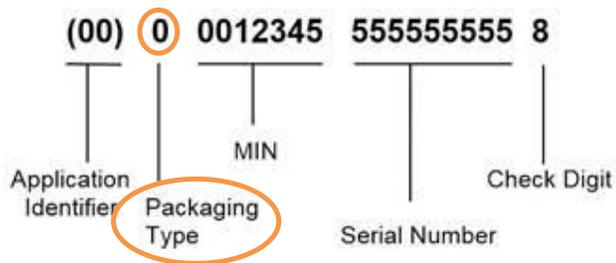

- For pack/case/carton level shipments, the individual pack/case/carton labels would include a “0” in the 3rd digit of the SSCC code.
- For pallet shipments, the pallet label would include a “1” in the 3rd digit of the SSCC code.

7.4.3. MASTER/OUTER CASE LABELING REQUIREMENTS FOR **NON-EDI VENDORS**

Indigo expects that the majority of our vendors are transacting via EDI. This section applies to all vendors that are not transacting via EDI.

i. **General Label Requirements (Non-EDI shipments)**

A labeling violation will occur if a label is missing or incorrect. Reasons why a label would be identified as missing or incorrect include:

- Label is not affixed to carton
- Defaced and/or partially missing label
- PO #, UPC, Carton QTY not indicated on the label
- Incorrect item UPC and/or carton QTY indicated on label
- Incorrect Ship-to included on the label
- Carton Weight is missing

ii. **Outer Case (Master Carton) Label Requirements for Non-EDI Vendors**

Each outer case must contain a Non-EDI Shipping Label as outlined below. Please produce the non-EDI carton label presented below, using the subsequent Zone content table also included below, and in the appropriate size. Place a label on each outer case in the shipment (an editable label template can be provided upon request).

Indigo Non-EDI Shipping Label Zones

The label is formatted into several information zones; it is very similar to Indigo's GS1-128 Shipping Label for ASNs provided above. Please see the illustration and zone explanations below.

*Illustration not to scale
Actual size = 4"x6"

Zone A	Ship From: Ship From Name Address 1 Address 2 City, State Postal Code		
Zone B	Ship To: Ship To Name Address 1 Address 2 City, State Postal Code		
Zone C	Carrier: B/L Number: PO #: Carton Qty:	Description of Product : UPC : 9781234567890 or 123456789012  Gross Weight of Case:	Zone D
Zone E	Final Destination: Final Destination Name Address 1 Address 2 City, State Postal Code		
Zone F	<div style="border: 1px solid black; padding: 20px; display: inline-block;"> <h1>NON EDI</h1> </div>		

Zone Content

A	Vendors ship from name and address <u>is required</u>	10 to 12 pt font
B	Ship to name and address <u>is required</u>	10 to 12 pt font
C	Shipment Information <ul style="list-style-type: none"> Carrier if available B/L # if available PO Number <u>is required</u> Carton quantity (# of total units in carton) <u>is required</u> 	10 to 16 pt font
D	Product Information <ul style="list-style-type: none"> Product Description <u>is required</u> UPC # <u>is required</u> if single product in the case; GS1-128 scannable barcode <u>is optional</u> (if available) Gross weight of the case <u>is required</u> 	10 to 16 pt font
E	Final Destination name and address (for Cross-Dock shipments only; leave blank for DC shipments)	10 to 16 pt font
F	"NON EDI" indicator <u>is required</u>	36 to 40 pt font

7.4.4. INNER CASE/PACK LABELING REQUIREMENTS (EDI & NON-EDI VENDORS)

The following requirements only apply if there is an Inner Case/Pack inside a Master Case. Indigo does not require an EDI GS1-128 label to be provided on inner cases/packs for EDI vendors; however, Indigo does require labeling for Inner Cases/Packs as follows:

- Each inner case/pack must be labeled with a human readable UPC of the product **AND** a scannable barcode of the UPC.
- The inner case pack label must include:
 - The unit quantity contained within the inner case/pack,
 - A description of the product.
- The inner case/pack label can be no smaller than 1" x 1"
- Use of a stencil and/or printed on the inner case/pack is permitted.

The inner case label must appear on one side only, in the upper right-hand corner.

7.4.5. LABELING FOR SPECIALTY PRODUCTS- EDI & NON-EDI VENDORS

Fragile Products

- Fragile or other product requiring special handling must be clearly labeled on the case.
- If commodities require special handling or stowage, the packaging should be marked accordingly; this information should also appear on the Bill of Lading.
- Any cautionary markings must be permanent and easy to read. Use the languages of both the country of origin and English.
- The use of stencils is recommended for legibility – do not use crayon, pencil, or chalk, which may be erased, or tags and cards, which may become detached.

Other Handling Indicators

- Expiry' and 'Best Before' dates must be clearly indicated on at least one side of each carton.
- Any goods requiring temperature control including protection from freezing must be identified as such on the carton and on the Bill of Lading. It is recommended that temperature requirements be clearly stated on the cartons as a guideline. Failure to identify goods in this manner may result in your account being charged for the value of the goods, freight and any excess freight to replace the goods in the event the carriers move goods without temperature controls and the goods are unsalable as a result.

Assortments

If "assortments" are being purchased by Indigo, please contact your Buyer or vendorcompliance@indigo.ca to further discuss the master data, Purchase Order and receiving processes associated with product of this nature. Indigo's experience has been that there are differing definitions of "assortments" in the General Merchandise community so this will assist in avoiding misunderstanding and poor supply chain execution. Please ensure that the UPC label on the assortment pack is the same UPC as ordered on the Purchase Order; **the assortment UPC should also be included in the respective ASN and invoice.**

7.4.6. LABELING COMPLIANCE TO CANADIAN LAWS AND REGULATIONS

- All case and package labeling must comply with all applicable Canadian laws and regulations, and must adhere to any prescribed national standards and warnings.
- Cost of all labeling is the responsibility of the vendor and must be included in the cost of the goods. Product must meet these conditions at time of shipment from vendor's facility or manufacturing site.
- Vendors may be asked to provide a copy of inner/outer case label for review, if necessary.
- Please refer to **The Case and Pallet Labeling Guidelines** for further detail.

Compliance

A **violation/infraction** means non-compliance with any component of this guideline for receipts under a single shipment.

Example:

- Non-compliance of the shipping label guideline on each carton of a 60-carton shipment in response to one Purchase Order constitutes a single violation, not 60 violations.

Failure to meet Indigo's requirements will lead to the respective shipment being subject to the applicable compliance chargeback.

7.5. PACKING GUIDELINE

Indigo's **Packing Guideline** applies to all product purchased for resale by Indigo Books & Music Inc. inbound to each of our DC and Store locations. This guideline plays a key role in ensuring that vendors provide the packaging, carton and pallet requirements for shipments to our DC and Store locations in the manner expected to support our supply chain productivity goals.

IMPORTANT: Please refer to the PACKING VENDOR GUIDELINES - ONLINE, RETAIL & DROP SHIP for full detail on ONLINE Packing requirements as there are further specific details for packing for this channel.

The Packaging Guideline includes Indigo's requirements for:

- Inner/Outer Case Pack
- Carton Specific Packaging
- Inner Packaging Material
- Pallet Specific Packaging
- Packaging for Specialty Product, including:
 - Fragile product
 - Apparel & Accessories
 - Food/Gourmet
 - Other
- Inner/Outer Package Labeling
- Environmental Reporting and Packaging Requirements
- Price Ticket Placement (on customer facing merchandise)

Indigo is an environmentally responsible company. We encourage the use of environmentally sensitive packaging materials (recycled and recyclable).

7.5.1. INNER/OUTER CASE PACK REQUIREMENTS

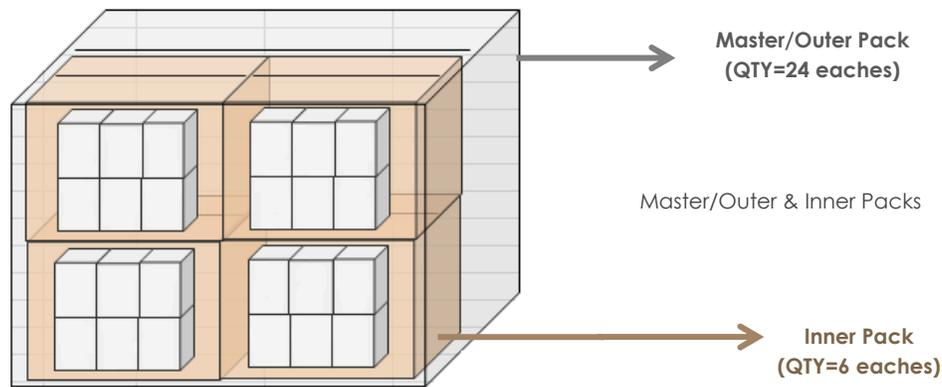

- All products must be packed in cartons/cases in accordance with the master/outer pack and inner pack quantities that are agreed to on the original Purchase Order. Any deviation in inner/outer pack quantities may result in a compliance chargeback.
- **Retail & Western DC requirement:** each outer case/master carton must contain only one SKU/UPC/EAN (exception: Online DC orders).
- **Requirement for all DCs:** Each inner case must contain only one SKU/UPC/EAN.
- **Requirement for all DCs:** Each outer case/carton must contain merchandise for only one Purchase Order.
- For Apparel & Accessories: each carton must contain only one style, colour and size combination (that is, one SKU/UPC).
- If a single SKU/UPC does not completely fill a carton, the remaining space must be filled with inner packaging material (dunnage).

7.5.2. CARTON SPECIFIC PACKAGING REQUIREMENTS

Master/Outer Pack (Carton) Packaging Requirements:

All products shipped to our DC & store locations must be packed in cartons/cases (the exception is some small couriered orders). At a minimum, all master/outer cartons/cases used to pack product to be shipped must be packaged according to the following standards:

Master/Outer Case - type/dimensions/weight:

- Cases must be made from new/clean corrugated cardboard.

- Cases must not exceed 23" (L) x 22" (W) x 16" (H) (exceptions for gift, toy and baby product must be pre-approved by the respective Indigo Category Manager ahead of delivery).
- Cases must be double-wall (5ply) with minimum edge crush strength of 50 lbs (22 kilos), and a bursting strength of 200lb/in² (1379kPa -13.4kg/cm²).
- Filled case weight must not exceed 40 lbs (exceptions must be pre-approved by the respective Indigo Category Manager ahead of delivery)
- Exceptions are for Food (liquids & semi-liquid) and Furniture which require a bursting strength of 275lb/in² (1896kPa - 18.4kg/cm²)
- The top and bottom seams of open cartons/cases must be sealed using strong packing tape.
- Use of binding, straps, staples, shrink-wrap or glue is not acceptable.
- The use of cardboard Gaylord boxes/containers, wooden or plastic crates are not permitted.

Master/Outer Case - Carton Markings:

- Carton Markings for master/outer case should include the following:
 - UPC number
 - Product Description
 - Carton Quantity
 - Carton Weight
- Only vendor markings regarding respective shipment, possibly corrugate manufacturer info, and courier label (if applicable) may be on master carton. No other markings are allowed.
- Product indicators, logos, and labels on the outside of the master carton must be for the product contained inside only.
- Special handling instructions must be indicated on the master carton (i.e. "fragile", "glass", "This way up", "Do not double stack" etc...).

Inner Pack Packaging Requirements:

Inner Case – type:

- Inner packs may be in the form of cartons or polybags, depending on item specifications.
- The top and bottom seams of open inner cases must be sealed using strong packing tape.

- Polybags must be clear and made from film that is at least 0.75 mil [19.0 µm] thick.
- If this is a polybag that Indigo's customer will ultimately receive, and it has an opening that is greater than 14 inches in circumference, then the polybag must have on it, printed legibly in black, the following anti-suffocation safety warning in both official languages:

"PLASTIC BAGS CAN BE DANGEROUS. TO AVOID DANGER OF SUFFOCATION KEEP THIS BAG AWAY FROM BABIES AND CHILDREN."

"LES SACS DE PLASTIQUE PEUVENT ÊTRE DANGEREUX. POUR ÉVITER LE DANGER DE SUFFOCATION, NE LAISSEZ PAS CE SAC À LA PORTÉE DES BÉBÉS NI DES ENFANTS"

- This warning may be expressed in different words if those words clearly convey the same warning.
- Inner packs must have a unique scannable and human readable UPC/EAN properly affixed.

Inner Case - Markings:

- Carton Markings for Inner Case should show:
 - Product Description
 - UPC number
 - Carton Quantity

Drop Test Requirement:

Please refer to the Appendix for the required Drop Test Procedure.

7.5.3. INNER PACKAGING MATERIAL REQUIREMENTS

- Although bulk shipments are warehoused at Indigo DCs, product must be packed properly to handle further distribution to Indigo Stores or online customers.
- At a minimum, all products should be packed inside a carton/case according to the following standards to ensure that they are adequately secured, supported and protected from damage during travel and handling:
 - Product must be properly protected using clean packing materials, and sufficiently separated from other items within the same container so as to avoid possible damage due to contact.
 - For Online DC orders, product must be packed as an individual Selling Unit – an Each or a Set – in an individual polybag, box or carton, ready for immediate shipment to our customer with no further repacking required at the Indigo Online DC; a UPC

barcode sticker must be affixed to the Unit/Single Pack (please refer to the **PACKING VENDOR GUIDELINES - ONLINE, RETAIL & DROP SHIP** for full detail)

- Inner voids within cartons/cases must be filled with packing materials (dunnage, air pillows,...).
- Packing materials requirements:
 - The use of Packing Paper (dunnage), Tissue, Air Pillows and Foam is permitted so long as they provide sufficient protective packaging for the products in the container.
 - The use of Packing Poly Peanuts, Newspaper, Printed Material, Hay, or Straw is not permitted.
- Protective packaging (i.e. polybags, tissue, 'baggies',...) must each be labeled (on the outside) with a scannable and human readable UPC of the product.
- All liquid products must have a sealed cap and must be packed to contain accidental leakage.
- All furniture or large items must be sufficiently packed to avoid damages from water and dust and to withstand long haul transportation.
- The use of polystyrene foam for packing furniture is permitted.
- All sharp or pointed objects/product edges must be wrapped in such a way so as to avoid puncturing the carton/case.
- Protective carton inserts are required on top of product to ensure knife damage will not occur.
- Please note: vendor is required to send thirty (30) days prior notification of any new configurations/packaging changes that will ship to Indigo's DC or Store locations.
- Notification must be sent via email to the respective Indigo Buyer and VENDORCOMPLIANCE@INDIGO.CA

7.5.4. PALLET SPECIFIC PACKAGING REQUIREMENTS (**WHERE APPLICABLE**)

Pallet Physical Properties:

Indigo requires that all inbound shipment pallets meet the following requirements:

- **Pallet dimensions:** 40" x 48"
- **Pallet Max Height:** must not exceed 52" inches (includes pallet + product height) - (exceptions must be pre-approved by Indigo Category Manager & DC Product Flow Manager, ahead of shipment/delivery)
- **Pallet type:**
 - Standard 4-way wooden pallets only

- o Please note: CHEP, CPC, plastic, 9-block, chipboard, and damaged pallets are **not acceptable**

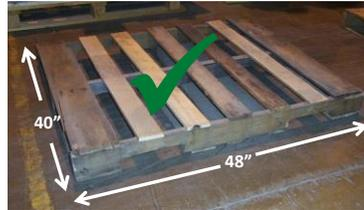

CHEP Pallet

Pallet Packing & Stacking:

- Shipments for which the total number of cartons make up more than 1 layer of a pallet should be palletized (exemption: floor loaded containers for sea shipments)
- A Pallet must contain product for one DC or store ship-to-location only (no mixed destinations).
- Heavier product must be placed on the bottom of the pallet.
- Where possible, cases/cartons containing the same item should be grouped together on the same pallet, **up to a maximum height of 52"**.
- All pallets must be securely shrink-wrapped with no overhang of product (see image below).
- Use of cardboard Gaylord boxes/containers, wooden/plastic crates are **not permitted**.
- Pallets may be double-stacked only if bottom pallet is leveled and the product on the bottom pallet will not get damaged.
 - o Shipper will take responsibility for any damage resulting from double-stacking.
 - o Triple stacking of pallets is **not** allowed.

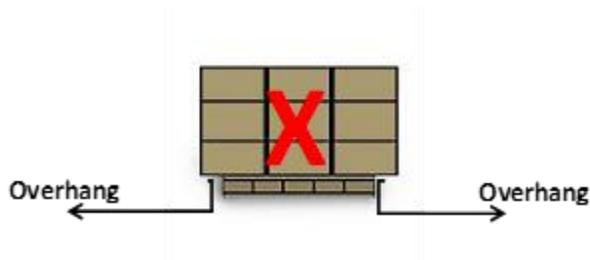

Special Considerations:

- Any merchandise shipment that requires special handling should be identified and pre-approved prior to the initial shipment by contacting the respective Indigo contact/buyer and the DC Transportation Manager.
- For example, in the event that filled case weight exceeds maximum allowable weight of 40 lbs (per case), as this will require special shipping arrangements.

Pallet Shipment – ASN Structure (EDI vendors only, if applicable)

For full or half-pallet shipments of a single product (i.e. single UPC): Indigo requires the vendor to provide a Pallet shipment, with either a:

1. **Pallet ASN** (SOTI structure), or
2. **Super-Pack ASN** (Super-pack SOPI structure)

(Please note that only one structure type (SOPI or SOTI) can be used per ASN, that is, one ASN cannot contain both SOPI and SOTI structure types.)

7.5.5. PACKAGING FOR SPECIALTY PRODUCTS

Fragile Products

- All fragile items (glassware, ceramics, gift items, furniture...) must be adequately packaged to protect merchandise from breakage or damage.
- If products require special handling or stowage, the packaging should be marked; this information should also appear on the Bill of Lading.
- Please refer to **Labeling for Specialty Products** in the Case & Pallet Labeling Guideline for further instruction on labeling Fragile product.

Apparel & Accessories

- All apparel merchandise, which is not already pre-packed in a floor-ready (branded) package, must be individually packed by size in polybags.
- Units sold as assortments/sets/pre-packs (using one UPC number) must be packed in the same polybag/carton in the full size assortment going to a store.
- Each master carton may contain only one UPC.
- Do not mix sizes, styles or colours in the same carton (unless they are part of an assortment/set/pre-pack under one UPC).
- Where available, clothing items should be shipped on a sales floor ready hanger.

Food/Gourmet (only where applicable)

- For food, gourmet and any other such product with a shelf life the 'Best Before' date must be clearly indicated on at least one side of each carton (in addition to being indicated on each of the item itself).
- Any goods requiring temperature control including protection from freezing must be identified as such on the carton and on the Bill of Lading.
- In order to ensure receipt and put-away within a 48hr window, gourmet/food and any other perishable product must be clearly indicated/identified as such:
 - On the Freight Notification Form (for Indigo controlled freight);
 - At time of booking a DC delivery appointment (for vendor-controlled freight).

Other

- Any pre-approved shipments containing oversized and/or heavy cartons must have "HEAVY" and/or "OVERSIZED" marked on the respective carton in either label or legible preprint carton marking format.
- Any cartons containing cosmetics must have the 'Expiry' and 'Best Before' dates clearly indicated (marked/labeled) on at least one side of each carton (in addition to being indicated on each of the item itself).

7.5.6. ADDITIONAL PACKAGING REQUIREMENTS

Product and Packaging Requirements:

Indigo will not accept illegally harvested wood and paper products. Indigo will immediately terminate business with vendors found to use such wood in its packaging materials.

Sustainable Packaging:

Where paper packaging is used (either corrugate or non-fluted paperboard packaging), Indigo prefers that vendors avoid virgin materials and use recycled materials.

Wood Packaging Requirements:

Please refer to *the Appendix section* for Indigo's wood packaging requirements.

7.5.7. PRICE STICKER SPECIFICATION & PLACEMENT (ON CUSTOMER FACING MERCHANDISE)- FOR RETAIL DC ORDERS

All merchandise must be shipped to our Distribution Centres and Stores with a scannable UPC or EAN barcode, and a Price Ticket/Sticker placed on the customer-facing merchandise (boxed/ wrapped or unboxed/unwrapped).

Please note: this guideline **does not apply** to Online merchandise (Online POs) shipping to the Online DC; **Online product should not have price stickers attached.**

Please refer to the **Indigo Private Label Brand Guidelines** document for Indigo's **brand standards and regulations for all Private Label General Merchandise** (price ticket guidelines).

Please ensure any labels or price stickers used are low-tack.

7.5.8. DAMAGE-FREE SHIPMENT/PRODUCT ("DAMAGE FREE")

- Indigo expects vendor shipments to be delivered damage-free, with all products packed according to Indigo's Packaging Guidelines.
- A shipment is considered to be damaged and non-compliant if there is any visible or concealed damage to the packaging and/or the product, rendering it not saleable.
- A damaged and non-compliant shipment may be subject to a compliance chargeback as per the Compliance Chargeback Schedule.
- Indigo will be noting any **visible damage** on the Bill of Lading at the time of offloading:
 - If vendor is responsible for freight, the damaged articles will be left on the carrier's trailer to be returned to vendor, and the respective invoice will be short paid for the respective amount. Vendor will be responsible for initiating the claim with their appointed carrier.
 - If Indigo is responsible for the freight terms, Indigo will initiate the claim with their appointed carrier.
- For **concealed damage**, Indigo will place the respective damaged items in their DC Quarantine and the respective invoice will be short paid as a result (for the amount of the damaged articles):
 - Vendor will be responsible for picking up the damaged product within seven (7) calendar days of being sent the notification by Indigo or may choose to pay Indigo to dispose of the damaged product. Indigo reserves the right to dispose of the goods if pick-up arrangements have not been made by the vendor within the 7 days. This policy applies to both our warehouses and all of our stores within Canada.
- In the event of any required sorting/reworking at the DC for damaged shipments, the respective hours of rework will be charged at a rate of \$75/hr as a Rework chargeback

SECTION 8 - VENDOR COMPLIANCE PROGRAM

SUMMARY

Indigo expects vendors to comply with the guidelines and requirements detailed in this manual. Non-compliance with these requirements disrupts Indigo's supply chain processes, thus affecting the high level of service we strive to deliver to our customers. Our vendor compliance policy is intended to recover incremental costs incurred by Indigo as a result of such non-compliance.

In the event a non-compliant shipment cannot be accepted, Indigo reserves the right to reject the shipment. In those instances, the vendor will be responsible for:

- All transportation and storage charges related to the rejected shipment;
- Arranging pick-up of the rejected freight within seven (7) calendar days of such notification being sent by Indigo. Indigo reserves the right to dispose of the goods if pick-up arrangements have not been made by the vendor within the 7 days. This policy applies to all our warehouses and stores within Canada.

8.1. COMPLIANCE CHARGEBACKS

Below is a list of our **Delivery Guidelines** and respective **Compliance Chargebacks** in the event of non-compliance (please note that new guidelines and/or chargebacks may be added at any time as required):

COMPLIANCE CHARGEBACK LIST			
Metric	Delivery Guideline	Violation	Chargeback Amount
ON-TIME	On-Time Shipment (OTS) Handed over to Carrier within Ship Window : Ocean/Air (outside NA): -10/+3 bus. days early/late vs CHO Land/Air (inside NA) -3/+3 bus. days early/late vs CHO	PO Handed Over to Carrier: Ocean/Air (outside NA): > 10 business days earlier than PO CHO Date > 3 business days after PO CHO Date Land/Air (inside NA): > 3 business days earlier than PO CHO Date > 3 business days after PO CHO Date	2% x QTY* early 5% x QTY* late *(PO value) 2% x QTY* early 5% x QTY* late *(PO value)

	<p>On-Time Delivery (OTD)</p> <p>Delivered to DC or Store within</p> <p>Delivery Window: 3 bus. days earlier/3 bus. days later than agreed to PO Delivery Date</p>	<p>Delivered to DC/Store:</p> <p>> 3 business days earlier than PO Delivery Date > 3 business days after PO Delivery Date</p>	<p>2% x QTY* early 5% x QTY* late *(PO value)</p>
	<p>ASN Delivery</p> <ul style="list-style-type: none"> ▪ Sent immediately after shipment departs from vendor's facility ▪ Received and processed successfully before delivery of physical shipment at DC/Store(s) 	<p>Missing/Late ASN:</p> <ul style="list-style-type: none"> ▪ EDI 856 not sent ▪ Flow Thru Missing ASN ▪ Valid EDI 856 sent late <ul style="list-style-type: none"> ○ Retail DC (RDC) ○ Western DC (CDC) ○ Online DC (ODC) ○ Store 	<p>\$250 per shipment for RDC/CDC</p> <p>\$100 per shipment for ODC/Stores</p>
	<p>DC/Store Delivery Requirements:</p> <ul style="list-style-type: none"> ▪ Appointment Booking ▪ Correct Address/Ship Location ▪ Paperwork 	<p>DC/Store Delivery:</p> <ul style="list-style-type: none"> ▪ No Appointment; Early/ Late Arrival ▪ Shipped To Wrong Location ▪ Paperwork Error/Missing Required paperwork (ie. BOL, Packing Slip, PO,...) 	<p>\$250 per PO</p>
COMPLETE	<p>Fill Rate</p> <p>PO Line 98%-102% filled on:</p> <ul style="list-style-type: none"> • Initial shipment • Overall PO 	<p>Fill rate variance from PO Line QTY</p>	<p>5% of non-compliant QTY* *(PO value not filled)</p>
ACCURATE	<p>Accurate Documentation</p> <ul style="list-style-type: none"> ▪ BOL Accuracy ▪ Packing Slip Accuracy 	<ul style="list-style-type: none"> ▪ Non-compliant/Missing BOL ▪ Non-compliant/Missing Packing Slip ▪ PO not on BOL 	<p>\$100 per violation/PO</p> <p>(applies to all cases of inaccuracy/invalidity)</p>

	Accurate EDI Documentation <ul style="list-style-type: none"> ▪ ASN Accuracy ▪ POA Accuracy ▪ Invoice Accuracy 	Various EDI document errors	\$100 per violation/PO
	Accurate UPC <ul style="list-style-type: none"> ▪ Correct UPC shipped ▪ Correct Product 	<ul style="list-style-type: none"> ▪ Wrong product shipped/incorrect UPC/ISBN ▪ UPC/ISBN Mismatch ▪ UPC/ISBN not on PO 	\$250 per PO
	Accurate Product Dimensions <ul style="list-style-type: none"> ▪ Correct Product Dimensions as per specification of ordered UPC. ▪ Correct Product Volume (based on Dims) ▪ Correct Product Weight 	<ul style="list-style-type: none"> ▪ Incorrect Product Dimensions ▪ Incorrect Product Volume ▪ Incorrect Product Weight ▪ Incorrect Carton Volume ▪ PIM Errors 	\$50 per UPC
	Accurate Case Pack QTY (Case Count)	<ul style="list-style-type: none"> ▪ Incorrect case pack quantity (case count) 	\$250 per PO
CASE & PALLET LABELING	Case & Pallet Label (General)	For both EDI/non-EDI Outer Case & Pallet Labels: <ul style="list-style-type: none"> ▪ Label Missing ▪ Label Barcode Not Scannable ▪ UPC Barcode Not Visible 	\$250 per PO
	Inner Case/Pack Label (for both EDI & non-EDI)	<ul style="list-style-type: none"> ▪ No Scannable UPC barcode on Inner Label ▪ No human readable UPC on Inner Label ▪ QTY not indicated on Inner Label ▪ Incorrect inner case QTY indicated ▪ Incorrect label placement (inner) 	\$250 per PO

	Outer Case Label (for both EDI & non-EDI)	<ul style="list-style-type: none"> ▪ Incorrect Label format ▪ Incorrect label placement (outer) ▪ Shipping Label Covered/Not Visible 	\$250 per PO
	Label Accuracy	<ul style="list-style-type: none"> ▪ Label missing: <ul style="list-style-type: none"> ○ Ship to/from address ○ UPC/ISBN ○ PO# ○ Case/Pallet QTY ○ HU (handling Unit) / SSCC18 code ▪ EDI label error ▪ HU Error: Incorrect/Mismatch/Duplicate 	\$250 per shipment
	Cross-Dock Label	<ul style="list-style-type: none"> ▪ Incorrect cross-dock label format ▪ Incorrect/Missing DC Dock Spot ▪ Incorrect Final Destination Name/Address indicated 	\$250 per PO
	Specialty Product/Handling Labels Polybag Markings	<ul style="list-style-type: none"> ▪ Special handling/stowage not labeled/marked ▪ Required label markings missing (i.e. FLOW THRU, SHERWAY 965, Street Sensitive, etc...) ▪ Markings not legible/erased, ▪ Markings not written in all required languages ▪ Expiry/Best Before dates/ Temperature Control not indicated when required ▪ Labeling error for Assortments 	\$250 per PO
PACKAGING	Single SKU cartons (applicable to General Merchandise product only; non Cross-Dock)	<ul style="list-style-type: none"> ▪ Mixed UPCs in inner case ▪ Mixed UPCs or POs in outer case 	\$250 per PO
	Inner Packaging Materials	<ul style="list-style-type: none"> ▪ Incorrect packaging material used 	\$250 per PO

	Pallet Requirements	<ul style="list-style-type: none"> ▪ Incorrect/bad pallet type ▪ Broken/Damaged Pallet ▪ Improper packing (bulk)/stacking ▪ Pallet overhang ▪ Maximum pallet height of 52 inches exceeded 	\$250 per shipment
	Carton Requirements <ul style="list-style-type: none"> • Correct Carton Weight • Correct Carton Dimensions • Correct Carton Volume (based on Case Dims) • Correct Carton Type • Carton Markings: UPC/QTY 	<ul style="list-style-type: none"> ▪ Filled Carton/Case weight > 40 LBS ▪ Incorrect Carton/Case dimensions ▪ Incorrect Carton/Case Volume ▪ Incorrect Carton Type ▪ Damaged Carton ▪ Missing Carton Markings: UPC/QTY 	\$250 per PO
	Pallet Shipments Should be a pallet shipment for single SKU pallet	<ul style="list-style-type: none"> ▪ Missed Pallet Shipment 	\$250 per PO
	Packaging for Specialty Products	<ul style="list-style-type: none"> ▪ Specialty Product not labeled/identified: <ul style="list-style-type: none"> ○ Fragile/heavy/oversized ○ Expiration date missing on Food/Gourmet/Cosmetics 	\$250 per PO
	Packaging for Apparel/Accessories	<ul style="list-style-type: none"> ▪ Apparel/Accessories not individually packaged (inner protective packaging) ▪ Mixed UPCs (non-assortment) per inner/outer case pack 	\$250 per PO
	Product Package Labels	<ul style="list-style-type: none"> ▪ No UPC barcode label on product packaging (including on individual item protective packaging) 	\$250 per PO
	Package Type	<ul style="list-style-type: none"> ▪ Unacceptable package type ▪ Bulk Vs Carton 	\$250 per PO

	Wood Packaging Requirements (import vendors only)	<ul style="list-style-type: none"> Violation of specified requirements (i.e. illegally harvested wood and paper products) 	\$250 per PO
	Price Sticker Requirements (on customer facing merchandise)	<ul style="list-style-type: none"> Violation of specified price sticker requirements (i.e. specifications, contents, placement,...) 	\$250 per PO
EDI	Transacting via EDI (i.e. EDI PO)	<ul style="list-style-type: none"> EDI non-compliance 	\$250 per non-compliant PO (non-EDI)
DAMAGE-FREE	Damage-Free Shipment	<ul style="list-style-type: none"> Damaged Shipment/product 	\$250 per PO
FLOW THRU	Flow Thru (F/T) Shipment Requirements (where applicable)	<ul style="list-style-type: none"> F/T pallet mixed with non F/T F/T – missing ASN F/T – partial case Other F/T error 	\$250 per PO
ROUTING	On-Time Booking	<ul style="list-style-type: none"> Late Booking Missed Pick-up/ Handover to Carrier 	\$250 per PO
	VGM Declaration	<ul style="list-style-type: none"> Cost of weighing container(s) at port VGM Declaration Non-Compliance 	Actual cost incurred per container (in CAD) \$100 USD per shipment
	Customs Documents	<p>Required commercial documents & Original BOL/Telex RIs not received by Delmar prior to freight arrival in Canada.</p> <ul style="list-style-type: none"> Customs hold Yard Storage: Container + Chassis Detention & Storage (container) Yard pull/movement (container) 	\$250 per PO with late customs documents incident \$250/day per container \$200 per yard pull, per container
QA	QA issue (as identified)	<ul style="list-style-type: none"> Per incident/violation Other charges as required/applicable 	\$250 per PO (+ Other charges as applicable)

PRODUCT DATA	Accurate & Complete Product Data	<ul style="list-style-type: none"> Refer to Product Data Compliance section for full detail 	\$50 per UPC (exception: \$100 per UPC for missing image)
ALL	Required Rework/Sorting to correct non-compliant shipment	<ul style="list-style-type: none"> For any sorting/rework required (at DC & Store locations) or, charged per unit (if required) – pricing TBD 	+ \$75/hr (in addition to fees above)

8.2. MEASURING NON-COMPLIANCE & NOTIFICATIONS

Non-compliance is measured daily based on the scheduled ETA and delivered condition of the Purchase Order. The delivery information is tracked, evaluated and measured against our supply chain delivery guidelines. Non-compliance detections and respective chargeback amounts are communicated weekly via email notification, details of which can also be found on our Compliance portal (<https://Indigo.TraverseSystems.com/>)

8.3. QUARANTINE

Non-compliant shipment may be placed in the **DC or Store Quarantine** until the error is corrected/resolved to enable receipt of the shipment. There is, however, a **DC Quarantine Threshold** of fifty dollars (\$50) for the total value of the non-compliant shipment, below which the contents of the respective shipment are disposed of to avoid inefficient use of labour and resources.

8.4. COMPLIANCE CHARGE DISPUTE PROCESS

Indigo allows vendors to dispute a compliance charge as follows:

- a dispute must be INITIATED on the Compliance portal with detail and respective supporting documentation;
- a dispute with no detail or supporting documents will be automatically denied.
- the dispute must be initiated within 60 (sixty) days of the chargeback notification (sent to vendor).

Examples of supporting documentation to include in a dispute:

- Reason for the dispute

- Signed delivery documentation (i.e. BOL, Packing slip, POD, ...)
- **For missing ASN infractions:**
 - the first 4 segments of the ASN X12 document; **or**
 - ASN ID, Date ASN sent, ICN
- Emails with supporting information/details/pre-approvals
- Copy of approved PO Change Request Form

SECTION 9 – SHIPPING GUIDELINES - INTERNATIONAL VENDORS

The Shipping Guidelines describe Indigo's inbound shipping processes and requirements for international vendors. All vendors are required to comply with these requirements to ensure efficient and timely product flow from vendor to Indigo.

Questions regarding Indigo's Shipping Requirements can be emailed to inbound@indigo.ca

Questions regarding Routing can be emailed to Indigoglobal@delmar.ca

This section includes:

1. Freight Terms and Responsibilities (summary table)
2. Inbound Shipment Requirements:
 - i. Packing Slip
 - ii. Bill of Lading
 - iii. Physical Presentation Requirements
 - iv. Routing Instructions
3. Domestic Shipment Procedure (shipments originating within Canada only)
4. International Shipment Procedures & Requirements (shipments originating outside of Canada, including from U.S.A.)

9.1.FREIGHT TERMS & RESPONSIBILITIES

The following chart summarizes the responsibilities of both the buyer and the seller for each of the current Inco-terms (an international set of trade terms).

		Incoterms 2010			
Incoterms for Multi-Modal Use:	EXW	Ex Works	DAT	Delivered at Terminal	
	FCA	Free Carrier	DAP	Delivered at Place	
	CPT	Carriage Paid To	DDP	Delivered Duty Paid	
	CIP	Carriage and insurance Paid To			
Incoterms for Non-Containerized Ocean Freight:	FAS	Free Alongside Ship	CFR	Cost and Freight	
	FOB	Free On Board	CIF	Cost, Insurance, Freight	

Buyer = B

Seller = S

Cost Headings											
Loading at seller's premises			S	S	S	S	S	S	S	S	S
Domestic pre-carriage/Local Cartage			S	S	S	S	S	S	S	S	S
Trade documentation in country of export	B	S	S	S	S	S	S	S	S	S	S
Export Customs clearance and any duty	B	S	S	S	S	S	S	S	S	S	S
Loading at carrier's terminal at origin	B	B	B	S	S	S	S	S	S	S	S
Loading at vessel at port of origin	B	B	B	S	S	S	S	S	S	S	S
International freight (main carriage)	B	B	B	B	S	S	S	S	S	S	S
Transport cargo insurance	B	B	B	B					S	S	S
Unloading of vessel at port of destination	B	B	B	B	B ⁽³⁾		S	S	S	S	S
Unloading at destination terminal	B	B	B	B	N/A				S	S	S
Trade documentation in country of import	B	B	B	B	B	B	B	B	B	B	
Import Customs clearance and any duty	B	B	B	B	B	B	B	B	B	B	
Domestic on-carriage/Local Cartage	B	B	B	B	B	B	B	B	B		
Unloading at buyer's premises	B	B	B	B	B	B	B	B	B	B	B
Other costs: Cost distribution according to party agreement not regulated in Incoterms											

- (1) It can be stipulated with a specific instruction that the seller, at his own expense, is to be responsible for certain loading requirements. This must be written into the contract in order for it to be effective
- (2) The named place following the INCOTERM "FCA" determines the point of transfer. If the named place is the seller's premise, the seller must LOAD the goods on the carrier's vehicle supplied by the buyer. If the named place is the carrier's terminal, the seller must DELIVER the goods to the named terminal and the buyer is responsible for payment to UNLOAD the vehicle at the carrier's terminal
- (3) Buyer pays unloading costs unless such costs were for the seller's account under the contract of carriage.
- (4) The point stated after "Delivered At Place" determines who is to pay the cost. If the point is indicated as DAP (buyer's premises), the cost is to be paid by the seller. If the trade term reads DAP (terminal) the seller has to pay the cost to that terminal, and the buyer has to pay the cost to the final destination.

9.2. INBOUND SHIPMENT REQUIREMENTS

9.2.1. PACKING SLIP

All shipments must be accompanied by a separate Packing List/Slip that should meet the following requirements, at a minimum:

- a. Each Packing List should contain:
 - Purchase Order #
 - Date of Shipment
 - Ship-to Location/Address (Destination)
 - List of UPC(s)
 - List of Product Description(s) Total units shipped
 - List of correct lot numbers (if applicable)
- b. For international shipments, the Packing List must include the number of cartons per SKU/per PO at the container level when shipping multiple containers under one MBL (Master Bill of Lading).
- c. Packing List should be easily identified on the outside of the shipment.
Packing List information should be accurate, reflecting the contents of the shipment

9.2.2. BILL OF LADING

- For EDI vendors, the Bill of Lading # must be included in the transmission of the ASN (Advanced Shipment Notification).
- All shipments must be accompanied by a Bill of Lading.
- *Express Bills of Lading* are requested whenever possible. At a minimum, the Bill of Lading should meet the following requirements (**ex. for shipping to Indigo's Retail DC**):

Shipper: Full name and address

Consignee: Indigo Books & Music Inc.
100 Alfred Kuehne Blvd, Building #55
Brampton, Ontario
L6T 4K4, Canada

Notify Party: Delmar International Inc
6399 Cantay Road
Mississauga, Ontario
Canada
L5R 0G4
Ph.: 905-206-1166
Fax: 905-206-9925

Shipment Details: No. of pallets
Weight
Purchase Order No.

Wood Packaging
Declaration:

If the shipment contains no solid wood packaging, please indicate on the Bill of Lading:

"Shipment contains no solid wood packaging material"

If the shipment contains fully marked solid wood packaging, indicate on the Bill of Lading:

"Shipment contains solid wood packaging materials marked in accordance with ISPM No. 15"

Please note: For Online DC orders, please indicate Building #50.

9.2.3. INTERNATIONAL (AIR & SEA) TRANSPORTATION DOCUMENT REQUIREMENTS

Surrender of ORIGINAL BILL OF LADING for international shipments (AIR & SEA)

- In order for the cargo to be released to Indigo, Delmar requires an **original bill of lading** or vendors can arrange a **telex release** with the Delmar origin offices.
- Indigo prefers that vendors hand in the original bills of lading (surrender) to the local Delmar origin office and request that origin issue a telex release to Delmar Toronto.
- Failing the above, original bills of lading are to be sent via courier to the attention of:

Delmar International Inc
6399 Cantay Road
Mississauga, Ontario
Canada
L5R 0G4

- The Original Bill of Lading is required to be surrendered to Delmar International within seven days of vessel departure.

9.2.4. PHYSICAL PRESENTATION REQUIREMENTS

For all physical presentation requirements, including case and pallet labeling, and packaging (inner/outer cartons/packs, pallets, etc...), please refer to the following two sections of this manual:

- Case & Pallet Labeling Guideline
- Packaging Guideline

9.3. ROUTING INSTRUCTIONS

- Once your freight is ready, please complete the **Freight Notification Form** (please refer to the Appendix Section) as per the procedures indicated in the **International Shipments** section to follow. Any questions should be directed to Delmar International (*please refer to the Contacts Section*).
- DAP and CIF vendors are also required to complete the **Pre-Alert Form** (please refer to the Appendix Section), and email it to Delmar International at INDIGOGLOBAL@DELMAR.CA
- If vendors are late in submitting either the Freight Notification Form or the Pre-Alert Form, a possible delay of the shipment may occur and the product may arrive later than the expected date (please refer to the submissions timeline on the form). This may result in a chargeback to the vendor.

9.4. DOMESTIC SHIPMENTS PROCEDURE (ORIGINATING WITHIN CANADA ONLY) – (IF APPLICABLE)

Once a Purchase Order has been issued, a **Freight Notification Form** (please refer to the Appendix Section) must be completed and e-mailed or faxed to Delmar International at IndigoNA@delmar.ca as advance notice for pick-up and drop-off at shipping point as follows:

Ground shipment: min. 3 business days in advance of CHO date (within North America)

Please note: If the expected product completion date is not going to be met, it is the responsibility of the vendor to advise the Indigo Category Manager as soon as possible.

Upon receipt of the Freight Notification Form (FNF), Delmar International will contact the vendor directly and provide routing instructions. Please note, in the absence of a prompt FNF, Delmar may contact the vendor to request the completed form for an upcoming order.

Vendor **must complete ALL fields of the freight notification form** at the time of making a booking with Delmar International, including:

- Indigo Purchase Order No.(s)
- Indigo Purchase Order Delivery Date(s)
- Ship-to Location/Address (Destination)
- Mode of Transport
- Shipment QTY
- Weight & cubic measure

All domestic shipments must be accompanied by:

- Bill of Lading (BOL)
- Packing Slip/List

For vendor-controlled freight:

All DAP and DDP vendors are required to contact Indigo's appointment desk to schedule a delivery. Please note all shipments require an appointment at either facility (Retail or Online).

All DAP and DDP vendors are required to have their delivery drivers wear Safety Shoes or Safety toe caps when entering an Indigo Distribution Center ("DC"). This is a Safety Requirement. Drivers will be refused entry into the Warehouse without Safety Shoes or Toe Caps. Additional safety requirements may also apply as per protocol at the given time (ie use of PPE, etc...)

9.5. INTERNATIONAL SHIPMENTS PROCEDURE & ADDITIONAL REQUIREMENTS (ORIGINATING OUTSIDE OF CANADA, INCLUDING FROM U.S.A)

PROCEDURE

Once a Purchase Order has been issued, a *Freight Notification Form* (please refer to the Appendix Section) must be completed and e-mailed or faxed to Delmar International as advance notice for pick-up and drop-off at shipping point as follows:

- a. **Ocean shipment:** min. 2 weeks in advance of CHO date
- b. **Air shipment:** min. 2 weeks in advance of CHO date (outside North America)
- c. **Ground shipment:** min. of 3 days in advance of CHO date (within North America)

Please note: If the expected product completion date is not going to be met, it is the responsibility of the vendor to advise the Indigo Category Manager as soon as possible.

For CIF and DAP vendors, a **Pre-Alert Form** (please refer to the Appendix Section) must be completed and e-mailed or faxed to Delmar International at INDIGOGLOBAL@DELMAR.CA

For shipments originating within North America, the vendor will be contacted directly by Delmar International in order to coordinate shipping details; however, **it is the vendor's responsibility to ensure the Freight Notification Form is submitted on time**. Upon receipt of the form, Delmar International will provide Routing Instructions to the vendor.

Vendor **must complete ALL fields of the Freight Notification Form** at the time of making a booking with Delmar International, including:

- Indigo Purchase Order No.(s)
- Indigo Purchase Order Delivery Date(s)
- Ship-To Location Address (Destination)
- Mode of Transport
- Shipment QTY
- Weight & cubic measure

9.5.1. SOLAS REQUIREMENT - VGM DECLARATION

For overseas shipments, as per the new IMO regulation titled Safety of Life at Sea (Solas) effective **as of July 1, 2016, all containers must have a declaration of the Verified Gross Mass (VGM) of the container (including Tare of the container) or it will not be loaded on the ship.** It is the responsibility of the shipper to supply this information to Delmar International at the time of making a booking, by filling a SHIPPER VGM DECLARATION form (either LCL or FCL). **Failure to do so could result in delayed shipments and additional weighing and holding charges, as well as respective non-compliance cost recovery charges.** Please refer to the **Appendix** section for the **IMO notice** issue May 23, 2016, and to **Appendix F** for the **Shipper VGM Declaration forms (LCL/FCL).**

There are two acceptable methods to obtain the VGM:

1. weigh the loaded container
2. weigh all the items loaded into the container (including dunnage, securing material, etc.) and add the tare mass of the container to the sum of those single masses

Delmar will need from the shipper of the cargo the following:

LCL

Upon completion of packaging the shipment for transport the shipper will need to insure they have an accurate VGM for each booking.

The shipment will **need to be weighed on qualified weighing equipment** (Qualified Weighing Equipment is defined as meeting the applicable accuracy standards and requirements of the State in which the equipment is being used.

You will then need to complete the attached document and submit it to the office with which you made the booking prior to the cargo being delivered.

This document must be signed by a person employed by your company authorized to sign the document.

FCL

Method 2:

As above, and add the tare which can be obtained from the imprint on the door of the container

Complete the attached document and submit it to the office with which you made the booking, this document should be sent when the loading of the container is complete and the seal is placed on the container and must be received prior to the container being delivered to the terminal. Again must be signed by an authorized person

Method 1:

Upon the conclusion of packing and sealing a container and using calibrated and certified equipment, the shipper may weigh, or have arranged that a third party weigh, the packed container. SOLAS Regulation, paragraph 4.1; IMO Guidelines, paragraph 5.1.1.

The scale, © weighbridge, lifting equipment or other devices used to verify the gross mass of the container must meet the applicable accuracy standards and requirements of the State in which the equipment is being used. IMO Guidelines, paragraph 7.1.

Whichever method is used you must then complete the attached document and submit it to the office with which you made the booking, this document should be sent when the loading of the container is complete and the seal is placed on the container and must be received prior to the container being delivered to the terminal. Again must be signed by an authorized person

(© 2016 Delmar International Inc All rights reserved. Solas VGM Regulations | Page 1 of 2 | 05.27.2016 -v.01)

For shipments originating outside of North America, the vendor will be provided with contact information of Delmar's local forwarding agent. This local agent will contact the vendor prior to the product completion date to arrange for collection.

All shipments entering Canada are subject to specific procedures and must be accompanied by a number of documents. These documents may vary according to the type of goods being shipped. Adherence to both procedures and proper document preparation will ensure a smooth transaction eliminating unnecessary and costly delays at customs.

9.5.2. ORIGINAL CUSTOMS DOCUMENTS

Original Customs Documents must be sent to Delmar International as follows (soft copies are acceptable via e-mail and can be sent to customsdocscan@delmar.ca :

- **For international ocean shipments:** the documents must be provided to Delmar not later than 3 days after departure.
- **For air and truck (North America):** the documents are required by Delmar prior to cargo departure.
- Failure to deliver Customs documents on-time will result in late document and storage/yard movement cost recovery charges as per the Cost Recovery Schedule

For Purchase Orders on Letters of Credit, the original customs documents must be sent to Indigo's Appointed Bank prior to the departure of the shipment.

All DAP and DDP vendors are required to contact Indigo's appointment desk to schedule a delivery. Please note all shipments require an appointment at either facility (Retail or Online).

All DAP and DDP vendors are required to have their delivery drivers wear Safety Shoes or Safety Toe Caps when entering any Indigo Distribution Center, as per a Safety Requirement. Drivers will be refused entry into the Warehouse without Safety Shoes or Toe Caps. Additional safety requirements may also apply as per protocol at the given time (ie use of PPE, etc...)

9.5.3. CANADIAN CUSTOMS CLEARANCE DOCUMENT REQUIREMENTS

INTERNATIONAL (AIR & SEA) SHIPMENTS:

All shipments entering Canada are subject to specific procedures and must be accompanied by a number of documents. These documents may vary according to the type of goods being shipped. Adherence to both procedures and proper document preparation will ensure a smooth transaction eliminating unnecessary and costly delays at customs.

Requirements:

- Customs Documents must be sent to Delmar International via e-mail and can be sent to Indiglobaldocs@delmar.ca
- **Email subject line must include Indigo PO# and ocean house bill of lading number.**
- Failure to have the Indigo PO# in the subject line and ocean bill of lading number will result in the documents being rejected.

Timing:

- **International OCEAN/SEA shipments:** Documents must be provided to Delmar **not later than 3 days after vessel departure.**
- **International AIR shipments:** Documents must be provided to Delmar **prior to cargo departure**
- Failure to deliver Customs documents on-time may result in late document and storage/yard movement compliance chargebacks.

Customs document package to include:

- commercial invoice
- packing slip
- certificate of origin if applicable
- copy of house bill of lading for ocean shipments
- copy house airway bill for air shipments

Commercial invoices must include the following information:

- country of origin
- currency
- complete address of vendor

- Indigo must be shown as importer of record
- date of direct shipment
- PO number(s)
- total Shipment quantity & total unit quantity
- detailed description including UPC #
- unit price & total line value
- Incoterm
- shipments moving under pre-paid terms must show freight value

NORTH AMERICAN (GROUND) SHIPMENTS:

Requirements:

- Customs Documents must be sent to Delmar International via e-mail to **pars@delmar.ca**
- Must be sent a minimum of 3 business days in advance of the CHO date.
- **Email subject line must include Indigo PO#**
- Failure to have the Indigo PO# in the subject line and ocean bill of lading number will result in the documents being rejected.

Customs document package to include:

- commercial invoice
- packing slip
- certificate of origin if applicable

Commercial invoices must include the following information:

- country of origin
- currency
- complete address of vendor
- Indigo must be shown as importer of record
- date of direct shipment
- PO numbers(s)
- total Shipment quantity & total unit quantity
- detailed description including UPC #
- unit price & total line value
- Incoterm

The table below is not an exhaustive listing of documents but rather the main documents required for the average import shipment.

Document	International Shipments	USA Shipments	Domestic Shipments
Canada Customs Invoice	required		
Commercial Invoice		required	
Packing Slip	required	required	required
Bill of Lading	required	required	required
Form 'A' / Exporter's Statement of Origin (when applicable)	required		
NAFTA Certificate of Origin (when applicable)		required	
Wood Packaging Requirements	required		
Letters of Credit (if required)	required		
Supplier VGM Declaration (applicable to Sea shipments only)	required		

9.5.4. CANADA CUSTOMS INVOICE/COMMERCIAL INVOICE

- For all commercial shipments entering Canada, a Commercial Invoice and/or Canada Customs Invoice must be supplied. Invoices do not require signatures and may be photocopies.
- The Commercial Invoice should include both the UPC (Item ID) being shipped, and the HS Code (Harmonized System Code).
- A copy of a Canada Customs Invoice and instructions for completion can be found in the Appendix Section.

9.5.5. FORM "A" CERTIFICATE OF ORIGIN (FOR SHIPMENTS ORIGINATING OUTSIDE OF NORTH AMERICA)

- Many countries throughout the world have been accorded a "General Preferential Tariff (GPT)" by Canada. In order for importers to benefit from lower rates of duty under the GPT (if applicable), a Form "A" Certificate of Origin or an Exporter's Statement of Origin is required for each import of qualifying goods.
- To qualify for GPT treatment, at least 60% of the ex-factory price of the goods packed for shipment to Canada must originate in one or more GPT countries. As well, the goods must be shipped directly on a through Bill of Lading to a consignee in Canada from the certified country. Please note: GPT tariff treatment and related favorable duty rates are scheduled to be eliminated Jan. 1, 2015.
- It is the sole responsibility of the exporter to determine the origin of the goods being exported and to provide a valid Certificate/Statement to that effect. It is the importer who benefits from the lower rates of duty (if applicable) when a Certificate/Declaration is supplied.

- If the exporter fails to complete a Certificate/Statement, all of the applicable duties on the goods will have to be paid.
- In lieu of the Form "A" Certificate of Origin, an Exporter's Statement of Origin may be supplied. The Exporter's Statement may be placed on the invoice or on a separate sheet indicating the invoice number.

This statement must read as follows:

Exporter's Statement of Origin

I certify that the goods described in this invoice or in the attached invoice # _____ were produced in the beneficiary country of _____ and that at least ___ per cent of the ex-factory price of the goods originates in the beneficiary country/countries of: _____.

Name and Title

Corporation name and address

Telephone and fax numbers

Signature and date (day/month/year)

The following can be found in the Appendix section:

- A copy of a Form "A" Certificate of Origin
- Instructions for completion
- A list of qualifying countries

9.5.6. NORTH AMERICAN FREE TRADE AGREEMENT (NAFTA) (FOR SHIPMENTS ORIGINATING WITHIN NORTH AMERICA)

Under the North American Free Trade Agreement (NAFTA), all tariffs between Canada and the USA have been eliminated as of January 1998. In order to define those goods entitled to the benefits of lower duty rates, a NAFTA Certificate of Origin or a NAFTA Low Value Declaration must be made.

9.5.7. NAFTA CERTIFICATE OF ORIGIN

- To ensure that only those goods which qualify under the Rules of Origin receive the benefits of the Agreement, a NAFTA Certificate of Origin (form B232) is required. The data to be

supplied on the Certificate is common for shipments to and from each country within the Agreement (ie, Canada, USA and Mexico).

- A copy of a NAFTA Certificate of Origin (form B232) can be found in Appendix K. Instructions for completion can be found in Appendix J.
- It is the sole responsibility of the exporter/producer to determine the origin of the goods being exported and to provide a valid Certificate to that effect. If the exporter/producer fails to complete a Certificate, all the applicable duties on the goods will have to be paid. Exporters/producers who certify goods eligible for NAFTA treatment must keep all certification related documents for a period of six (6) years.
- Blanket NAFTA certificates can be submitted for multiple shipments of the same goods to the same importer. The validity period of a blanket certificate in Canada is one (1) year.

9.5.8. NAFTA LOW VALUE DECLARATION:

Certification of shipments to Canada under \$1600.00 CDN in value can be performed with an authorized signature on the commercial invoice (i.e. no Certificate of Origin is required). This certification attests that the goods comply with origin requirements and that further processing or assembly has not taken place in a non-originating country.

This statement must read as follows:

NAFTA Low Value Certification

I certify that the goods referenced in this invoice/sales contract originate under the rules of origin specified for these goods in the North American Free Trade Agreement (NAFTA), and that further production or any other operation outside the territories of the Parties has not occurred subsequent to production in the territories

Name and Title

Company

Telephone and fax numbers

Signature and date (day/month/year)

I am the exporter of the goods ___ or producer of the goods ___.

SECTION 10 - CONTACTS

1. DISTRIBUTION CENTRES & SHIPPING

MAILING / DELIVERY ADDRESSES	
Location	Address
Retail Distribution Centre	100 Alfred Kuehne Boulevard Building # 55 Brampton, ON, Canada L6T 4K4
Online Distribution Centre	100 Alfred Kuehne Boulevard Building # 50 Brampton, ON, Canada L6T 4K4
Western Distribution Centre (Calgary)	5800, 79 Avenue South East, Unit #10 Calgary, AB, Canada T2C 4S6

HOURS OF OPERATION		
Location	Phone	Business Hours
Retail Distribution Centre	Bus: 905-789-1234 800-974-7381	Sunday 11:00pm– Friday 11:10pm (EST)
Online Distribution Centre	Bus: 905-789-1234 ext. 2697 or 2689 800-974-7381 ext. 2697 or 2689	Sunday 11:00pm– Friday 11:10pm (EST)
Western Distribution Centre (Calgary)	Receiving Office: (403) 523-7657 ext 5370 Security Office: (403) 523-7657 ext 5364	Mon-Friday: 7:00 am - 2:30 pm (GMT)

APPOINTMENT DESK HOURS		
Location	Phone	Appointment Desk Hours
Retail & Online Distribution Centre	Bus: 905-789-1234 ext. 512 800-974-7381 ext. 512 DCinboundappointments@indigo.ca	Mon-Fri 7:00am - 3:00pm (EST) (messages left after 12:00pm (noon) may be returned the following day)
Western Distribution Centre (Calgary)	Please submit appointment requests to CDCapptscheduling@indigo.ca	Mon-Thurs: 7:00 am - 2:30 pm (GMT) Deliveries will be scheduled Mon-Thurs from 8:30 am to 6:00 pm (GMT)

KEY CONTACTS			
Inquiry	Contact	Phone	Business Hours
Shipping Inquiries	inbound@indigo.ca		Monday - Friday 9:00 am – 5:00 pm (EST)
Routing <ul style="list-style-type: none"> • International • Domestic & North America 	Delmar International IndigoGlobal@delmar.ca IndigoNA@delmar.ca	Fax: 905-206-9925 Fax: 514-636-1212	
Customs & Brokerage	IndigoCustoms@delmar.ca	Fax: 905-206-9925	
Pre-Alert Forms	CustomsDocsCan@delmar.ca	Fax: 905-206-9925	

2. VENDOR COMPLIANCE, EDI, MASTER DATA, DROP SHIP

KEY CONTACTS			
Inquiry	Contact	Phone	Business Hours
EDI (Electronic Data Interchange)	Indigo EDI Support EDISupport@indigo.ca InterTrade Customer Support support@intertrade.com InterTrade ecCatalogue solutions@intertrade.com	1-800-873-7803	Monday to Friday 9:00 AM – 5:00 PM (EST) Monday through Friday, excluding holidays) 8:30am – 8:00pm EST
Master Data (PIM)	PIM@indigo.ca		Monday to Friday 9:00 AM – 5:00 PM (EST)
Vendor Onboarding/ Set-up	vendorSetup@indigo.ca		Monday to Friday 9:00 AM – 5:00 PM (EST)
Vendor Compliance	vendorCompliance@indigo.ca		Monday to Friday 9:00 AM – 5:00 PM (EST)
Compliance Chargebacks & Disputes	logon to the compliance portal (24/7) https://Indigo.TraverseSystems.com		

3. QUALITY ASSURANCE, SUSTAINABILITY, DEI & ETHICAL SOURCING

KEY CONTACTS			
Inquiry	Contact	Phone	Business Hours
Senior Manager, Product Quality	Kitty Tang ktang@indigo.ca		Monday to Friday 9:00 AM – 5:00 PM (EST)
Sustainability & Ethical Sourcing	Geoff Suares GSuares@indigo.ca		
Diversity, Equity & Inclusion (DEI)	Madeleine Lowenborg-Frick diversity@indigo.ca		

4. ACCOUNTS PAYABLE

KEY CONTACTS			
Inquiry	Contact	Phone	Business Hours
Accounts Payable	A/P Dept. 100 Alfred Kuehne Boulevard Building # 55 Brampton, ON, Canada L6T 4K4		Monday to Friday 9:00 AM – 5:00 PM (EST)
A/P - Invoice Payment <u>Attention to:</u>			
General Merchandise: (Toys, Gifts, Games, Paper Product)	Sharon Garzon SHARON_G@INDIGO.CA		
Consignment	Barbara Kozimor Barb_k@indigo.ca		
Music, Entertainment, Videos/DVD and Electronics	Genieve Carridice GCARRIDICE@INDIGO.CA		

SECTION 11 – APPENDICES

A. WOOD PACKAGING REQUIREMENTS

Wood Packaging Requirements (for Import Vendors only)

- All wooden pallets coming into Canada must conform to the Canadian Food Inspection Agency (“CFIA”) standards.
- Canada’s wood packaging import regulations adhere to the principles of “ISPM No. 15: Guidelines for Regulating Wood Packaging Material in International Trade” as issued in March 2002 by the International Interim Commission on Phytosanitary Measures of the International Plant Protection Convention.
- Importations of non-manufactured wood treated by heat treatment process (Kiln Drying) will only be allowed from countries which have had their monitoring program (heat treatment verification system) pre-approved by CFIA.
- Importations containing wood packaging that does not meet ISPM No. 15 standards will be refused entry into Canada and must be returned to the country of export at the supplier’s expense.
- Shipments arriving in North America from Offshore
- Proof of Treatment
- Upon import, proof of treatment (copy of the International Plant Protection Convention (“IPPC”) Stamp Coding) is required to gain release from the appropriate Plant Protection Organization of Canada, USA or Mexico.
- The IPPC symbol for treated wood packaging materials (as per Annex II of the “International Standard for Phytosanitary Measures #15: Guidelines for Regulating Wood packaging materials Material in International Trade”):

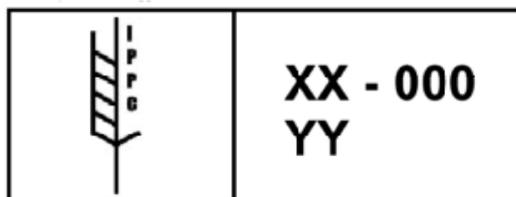

- Where XX represents the International Standards Organization two letter country code for the country in which the wood packaging is produced and 000 represents the official certification number issued to the facility producing the compliant wood packaging by the National Plant Protection Organization and YY represents the treatment carried out (e.g. HT for heat treated wood or MB for methyl bromide treated wood).

1. EXCEPTIONS

- There are no exceptions to the policy. Non-compliant wood packaging will be ordered "removed from Canada". Upon request, and approval by Customs, the non-compliant wood packaging may be separated from the shipment at an approved facility.
- All costs (cartage, unloading, reloading, fumigation of non-compliant materials, destruction of materials, cartage back to Customs) will be the responsibility of the entity in care and control of the shipment. Note, this is a potential option only and circumstances will be reviewed by Customs on a case-by-case basis.

2. SHIPMENTS ARRIVING IN CANADA FROM USA

- Wood packaging manufactured from wood of USA origin that has not moved internationally is exempt from the treatment and marking requirements of Canadian wood packaging import regulations.
- There are no requirements for treatments, marking or declaration for shipments imported into Canada from the USA. Shipments moving through the USA for ultimate destination in Canada are subject to full International regulations.

3. SHIPMENTS ARRIVING IN USA/CANADA FROM MEXICO

- The same regulations for Shipments to North America from Offshore apply to all imports into Canada/USA from Mexico.

4. EXPORTER DECLARATIONS

No Solid Wood Packaging

- If the shipment contains no solid wood packaging a "declaration" should be stated on the bill of lading to alert Customs/Agriculture and potentially avoid unnecessary inspections, for example "Shipment contains no solid wood packaging materials – pallets used are plywood"

Marked Wood Packaging

- If the shipment contains fully marked solid wood packaging, a declaration should be provided on the bill of lading to state "Shipment contains solid wood packaging materials marked in accordance with ISPM No. 15".
- Detailed wood packaging information can be found at [HTTP://WWW.INSPECTION.GC.CA](http://www.inspection.gc.ca)

B. QA REQUIREMENTS

Indigo Test Request Forms

Hard Lines Test Request Form

		HARDLINES TEST REQUEST FORM					
Please type or print in BLOCK LETTERS							
Company Submitting For		Indigo, Inc. (JDE # 236194)			Purchase Order No.		Indigo PO #
Submitter (Company)		Vendor name			Submitter Contact		Vendor
Address		Vendor	City		Vendor	State	Vendor
Phone		Vendor	Fax		Vendor	BVCPs Contact	
						If known, enter BV contact name, otherwise leave blank	
Report Recipient		Vendor			E-mail Address		
Invoice Recipient		Vendor			E-mail Address		
SAMPLE INFORMATION:							
Sample Description		Product description as appears on the Indigo Purchase Order				No. of Cartons	
SKU/Style No.		UPC number as appears on the Indigo Purchase Order				No. of Samples	
						# of samples	
Item No.		Vendor	Lot No.		Vendor	Manufacturer	
						Vendor or factory name	
Country of Distribution		Canada		Country of Origin		Country where item was manufactured	
<input type="checkbox"/> Return Sample (shipping and handling charges apply)							
SERVICE REQUIRED*: (Check One)							
<input checked="" type="checkbox"/> Regular (7 - 10 business days)							
<input type="checkbox"/> Same Business Day (sample receipt by 10:30 a.m.)**							
<input type="checkbox"/> Next Business Day from receipt of sample**							
<input type="checkbox"/> Next 2 Business Days from receipt of sample**							
<input type="checkbox"/> Next 3 Business Days from receipt of sample**							
<input type="checkbox"/> Next 5 Business Days from receipt of sample**							
*Special requests or unique testing may require additional time				**Additional Charges Apply			

Test Request Form - Garment and Textiles

		TEST REQUEST FORM GARMENT AND TEXTILES					
Submitting for:		Indigo, Inc. (JDE# 236194)					
Your Company Name:		Vendor name			Purchase Order No.:		
					Indigo PO #		
Address:		Vendor	City		Vendor	Province	Vendor
						Postal Code	Vendor
Contact Person:		Vendor			Phone:		
					Vendor		
Fax:		Vendor			E-mail:		
					Vendor		
Invoice Recipient:		Vendor			Report Copies To:		
					Vendor		
Submitting for (Industry Standard's or to a specific client's standards):							
Sample Description:		Product description as appears on the Indigo Purchase Order				# of Samples Submitted:	
						# of samples	
Manufacturer / Vendor:		Vendor or factory name				# of Cartons:	
SKU / UPC:		UPC number as appears on the Indigo Purchase Order		Country of Origin:		Country where item was manufactured	
						Return Samples? <input type="checkbox"/> No <input type="checkbox"/> Yes*	
Item / Style #		Vendor		Country of Distribution:		Canada	
						*List courier & acct #	
Fiber Content:		Vendor		Color:		End Use:	
<input checked="" type="checkbox"/> REGULAR SERVICE (5 - 7 business days)		<input type="checkbox"/> EXPRESS (3 Day Service Surcharge 40%)			<input type="checkbox"/> PRIORITY (24 Hour Service) Surcharge: 100% *		
* Limited tests available. Please call for details							

Test Request Form - Toy & Juvenile Products

		TEST REQUEST FORM TOY AND JUVENILE PRODUCTS			
<input type="checkbox"/> QUOTATION REQUIRED BEFORE TESTING (testing only starts upon receipt of signed quotation with complete information and samples. Please note that quotation fees may apply for this service)					
Submitting for: Indigo, Inc. (JDE# 236194)					
Your Company Name:		Vendor name		Purchase Order No.: PO #	
Address:		Vendor		City:	Vendor
Contact Person:		Vendor		State:	Vendor
Phone:		Vendor		Fax:	Vendor
				E-mail:	Vendor
Name of Importer of Record or Domestic Manufacturer:		(Remark: This importer of record/domestic manufacturer information is required for CPSIA's General Conformity Certificate)			
Mailing Address/ Tel No.:					
Date of Manufacture (MM/DD/YY):		Place of Manufacture (City/Province/Country):			
Sample Description:		Product description as appears on the Indigo Purchase Order		# of Samples Submitted: # of samples	
Manufacturer / Vendor:		Vendor or factory name		(7 samples preferred)	
SKU / UPC:		UPC number as appears on the Indigo Purchase Order		Country of Origin: Country where item was manufactured	
Item / Style #:		Vendor		Return Samples? <input type="checkbox"/> No <input type="checkbox"/> Yes*	
		Country of Distribution: Canada		*List courier & acct #:	
SERVICE REQUIRED: (Check One) <input checked="" type="checkbox"/> Regular (7 business days)					
<input type="checkbox"/> Next 3 Day (40% surcharge) <input type="checkbox"/> Next 2 Day (50% surcharge) <input type="checkbox"/> Next Business Day* (100% surcharge)					
<input type="checkbox"/> Express (100% surcharge for extended time tests)* <input type="checkbox"/> Same Business Day* (175% surcharge)					
<small>* - Sample including completed paperwork for rush services must be in receipt of BV by 10:30am required.</small>					

Drop Test Procedures

The following describes the procedures for performing a drop test for protective packaging according to ISTA-1A standards.

Carton Drop Test consists of a '10-drop sequence test.' Package weight cannot exceed 40 lb. The test consists of a series of ten free-fall drops from heights that vary with weight as follows:

Imperial		Metric	
Package Weight	Drop Height	Package Weight	Drop Height
1 – 75 lb.	30 inches	1 – 34 Kg	76 cm
76 – 100 lb.	24 inches	35 – 45 Kg	61 cm

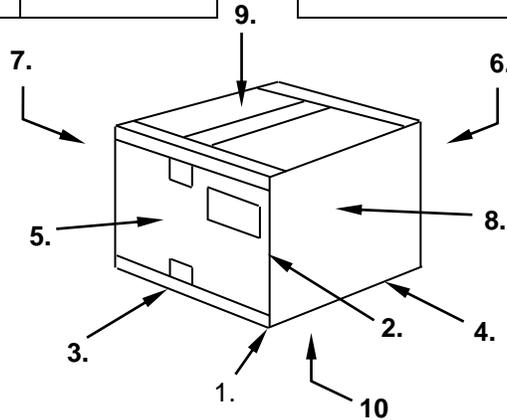

The test must be performed in following order:

1. Most fragile corner, if not known, at the carton manufacturer's joint
2. Shortest edge radiating from that corner
3. Medium edge radiating from that corner
4. Longest edge radiating from that corner
5. Flat on one of the smallest faces
6. Flat on the opposite small face
7. Flat on one of the medium faces
8. Flat on the opposite medium face
9. Flat on one of the largest faces
10. Flat on the opposite largest face

ALLERGEN CHECKLIST FOR FOOD SUPPLIERS & MANUFACTURERS (SAMPLE ONLY)



ALLERGEN CHECKLIST FOR
FOOD SUPPLIERS AND MANUFACTURERS

Original Form Amended Form

Product Name: _____ UPC # _____

Complete the following table **for each product**. Column I indicates the allergens that may be found in the product, from addition or cross-contamination. Column II indicates the allergens present in other products that are run on the same equipment but at a different time. Column III indicates whether any allergens are present in your plant.

Fill in each cell of the table with a **YES** or a **NO** and, when applicable, include the name of the ingredient.

DO NOT LEAVE ANY CELLS BLANK.

Component	Column I Present in the product	Column II Present in other products manufactured on the same line	Column III Present in the same manufacturing plant
Peanut or its derivatives, e.g., Peanut - pieces, protein, oil, butter, flour, and mandelona nuts (an almond flavoured peanut product) etc. Peanut may also be known as ground nut .			
Tree Nuts (almonds, Brazil nuts, cashews, hazelnuts (filberts), macadamia nuts, pecans, pine nuts (pinyon, pinon), pistachios and walnuts or their derivatives, e.g., nut butters and oils etc.			
Sesame or its derivatives, e.g., paste and oil etc.			
Milk or its derivatives, e.g., milk caseinate, whey and yogurt powder etc.			
Eggs or its derivatives, e.g., frozen yolk, egg white powder and egg protein isolates etc.			
Fish or its derivatives, e.g., fish protein, oil and extracts etc.			
Crustaceans (including crab, crayfish, lobster, prawn and shrimp) and Shellfish (including snails, clams, mussels, oysters, cockle and scallops) or their derivative, e.g., extracts etc.			
Soy or its derivatives, e.g., lecithin, oil, tofu and protein isolates etc.			
Wheat, triticale or their derivatives, e.g., flour, starches and brans etc. Includes other wheat varieties such as spelt, durum, kamut, emmer etc. and includes all gluten sources.			
Mustard or its derivatives, e.g., mustard seeds, mustard flour, ground mustard, prepared mustard etc.			
Sulphites , e.g., sulphur dioxide and sodium metabisulphites etc. (if YES, indicate amount ppm)			
Others (as considered necessary)			

Do you have procedures to avoid cross-contamination of the product with the allergens not present

in the product but noted in columns II and III? Yes No (If yes, describe procedures on back or on separate page.)

Attach a finished product label to this form for each product. **If, for any reason, there are any modifications to this product, you are responsible for updating your records including labels and specifications, and notifying us immediately.**

Vendor Name: _____

Vendor Address: _____

Manufacturing Facility Name: _____

Manufacturing Facility Address: _____

This form has been completed by responsible technical staff, as indicated by the undersigned:

Name: _____ Signature: _____ Date: _____

Certificate of insurance (COI) requirements matrix – by product type

MERCHANDISE CATEGORY	PRODUCT CATEGORY	INSURANCE LIMIT
PAPER	BOOK ACCESSORIES - BOOK LIGHTS	\$1M
PAPER	BOOK ACCESSORIES - BOOK MARKS	\$1M
PAPER	CALENDARS	\$1M
PAPER	DIY CRAFT KITS (DÉCOR, TIE DYE, ETC.)	\$1M
PAPER	GADGETS & TOOLS (electric)	\$1M
PAPER	GADGETS & TOOLS (non-elec)	\$1M
PAPER	GIFT WRAP - GIFT BAGS, WRAPPING PAPER, GIFT TAGS, BOWS, RIBBON	\$1M
PAPER	HOME - OFFICE FURNITURE	\$1M
PAPER	HOME - OFFICE FURNITURE (adult, non-electric)	\$1M
PAPER	JOURNALS / AGENDAS/ PLANNERS	\$1M
PAPER	LAP DESKS	\$1M
PAPER	NOVELTY GIFTS & ACCESSORIES (non-electric)	\$1M
PAPER	OFFICE - ACCESSORIES & SUPPLIES (Eg. PAPERCLIPS, STAPLER, TACKS, SCISSORS, ETC...)	\$1M
PAPER	OFFICE - DESKTOP GAMES & OBJECTS (Eg DOCUMENT TRAY, PEN HOLDER, PAPERWEIGHT, BOOKENDS, ETC)	\$1M
PAPER	PAPER - GREETING CARDS	\$1M
PAPER	PAPER - NOTEBOOKS	\$1M
PAPER	PAPER - NOTEPADS	\$1M
PAPER	PAPER - RECIPE BINDER/BOX/CARDS	\$1M
PAPER	PAPER - SKETCHBOOKS	\$1M
PAPER	PAPER - STATIONERY	\$1M
PAPER	PARTYWARE - DECORATIONS & ACCESSORIES	\$1M
PAPER	PARTYWARE - PAPER PLATES, NAPKINS, CUPS, DECORATIONS	\$1M

PAPER	PHOTO ALBUMS	\$1M
PAPER	WRITING TOOLS (PENS, MARKERS,PENCILS, SHARPENERS, INK, ETC...)	\$1M
LIFESTYLE	APPAREL & ACCESSORIES (ADULT)	\$1M
LIFESTYLE	APPAREL & ACCESSORIES (ADULT) - BELTS	\$1M
LIFESTYLE	APPAREL & ACCESSORIES (ADULT) - COLD WEATHER	\$1M
LIFESTYLE	APPAREL & ACCESSORIES (ADULT)- SOCKS & SLIPPERS	\$1M
LIFESTYLE	APPAREL (ADULT) - FOOTWEAR	\$1M
LIFESTYLE	APPAREL (ADULT) - HATS	\$1M
LIFESTYLE	APPAREL (ADULT) - MATERNITY	\$1M
LIFESTYLE	APPAREL (ADULT) - PAJAMAS & SLIPPERS	\$1M
LIFESTYLE	APPAREL (ADULT) - ROBES/SHAWLS	\$1M
LIFESTYLE	APPAREL (ADULT) - SLEEP ESSENTIALS	\$1M
LIFESTYLE	APPAREL (ADULT) - SLEEP MASKS	\$1M
LIFESTYLE	ART - PAINTINGS	\$1M
LIFESTYLE	ART - PRINTS	\$1M
LIFESTYLE	BAGS - BACKPACK	\$1M
LIFESTYLE	BAGS - COSMETIC/TOILETRY BAGS	\$1M
LIFESTYLE	BAGS - CROSSBODY	\$1M
LIFESTYLE	BAGS - DIAPER BAG	\$1M
LIFESTYLE	BAGS - HANDBAGS	\$1M
LIFESTYLE	BAGS - LAPTOP	\$1M
LIFESTYLE	BAGS - LUNCH BAGS/TOTES	\$1M
LIFESTYLE	BAGS - TOTES	\$1M
LIFESTYLE	BAGS - TRAVEL & LUGGAGE	\$1M
LIFESTYLE	BAGS - WALLETS/CASES/POUCHES	\$1M
LIFESTYLE	BAKEWARE (non-electric)	\$1M

LIFESTYLE	BATTERIES - ELECTRIC/ RECHARGEABLE/ PORTABLE BATTERY PACKS	\$1M
LIFESTYLE	CAMERAS/ CAMCORDERS/ ACCESSORIES (electric/rechargeable)	\$1M
LIFESTYLE	CDs/DVDs/VINYL RECORDS	\$1M
LIFESTYLE	EYEWEAR - READING GLASSES	\$1M
LIFESTYLE	EYEWEAR- SUNGLASSES	\$1M
LIFESTYLE	GRILLING - BARBEQUE (NON-PROPANE) , TOOLS & ACCESSORIES	\$1M
LIFESTYLE	HAIR - ACCESSORIES (excluding baby & kids)	\$1M
LIFESTYLE	HOLIDAY DÉCOR/ ORNAMENTS/ NOVELTY - ELECTRIC/LIGHTS	\$1M
LIFESTYLE	HOLIDAY DÉCOR/ ORNAMENTS/ NOVELTY (non-elect, non-fragile/breakable)	\$1M
LIFESTYLE	HOLIDAY DÉCOR/ ORNAMENTS/ NOVELTY (non-fragile/breakable)	\$1M
LIFESTYLE	HOME - BAR CARTS & ACCESSORIES	\$1M
LIFESTYLE	HOME - BEDDING (SHEETS, LINENS, PILLOW COVERS)	\$1M
LIFESTYLE	HOME - CANDLE ACCESSORIES (ie Candleholders)	\$1M
LIFESTYLE	HOME - CANDLES	\$1M
LIFESTYLE	HOME - CANDLES & INCENSE	\$1M
LIFESTYLE	HOME - CANDLES (FLAMELESS/electric)	\$1M
LIFESTYLE	HOME - COFFEE BREWING & ACCESSORIES	\$1M
LIFESTYLE	HOME - COOKWARE	\$1M
LIFESTYLE	HOME - DECOR - BASKETS	\$1M
LIFESTYLE	HOME - DECOR - BLANKETS (electric)	\$1M
LIFESTYLE	HOME - DECOR - CLOCKS (non-elec)	\$1M
LIFESTYLE	HOME - DECOR - DIGITAL PHOTO FRAMES (electric)	\$1M
LIFESTYLE	HOME - DECOR - FRAMED ART	\$1M
LIFESTYLE	HOME - DECOR - FRAMES (non-elec)	\$1M
LIFESTYLE	HOME - DECOR - MESSAGE BOARDS	\$1M

LIFESTYLE	HOME - DECOR - MIRRORS	\$1M
LIFESTYLE	HOME - DECOR - OUTDOOR & GARDEN (tools, electric, organic...)	\$1M
LIFESTYLE	HOME - DECOR - OUTDOOR & GARDEN ACCESSORIES (non-elec)	\$1M
LIFESTYLE	HOME - DECOR - PILLOWS	\$1M
LIFESTYLE	HOME - DECOR - SHELVING	\$1M
LIFESTYLE	HOME - DECOR - THROWS & BLANKETS (non-electric)	\$1M
LIFESTYLE	HOME - DECOR - WALL DECALS	\$1M
LIFESTYLE	HOME - DECOR - WALL DÉCOR (non-elec)	\$1M
LIFESTYLE	HOME - DIFFUSERS	\$1M
LIFESTYLE	HOME - DIFFUSERS (non-electric, no use of essential oil)	\$1M
LIFESTYLE	HOME - DINNERWARE	\$1M
LIFESTYLE	HOME - DISHWARE	\$1M
LIFESTYLE	HOME - DRAPERY & BLINDS	\$1M
LIFESTYLE	HOME - ESSENTIAL OILS	\$1M
LIFESTYLE	HOME - FOOD PREPARATION	\$1M
LIFESTYLE	HOME - FOOD STORAGE	\$1M
LIFESTYLE	HOME - FURNITURE (non-baby & non-electric)	\$1M
LIFESTYLE	HOME - GLASSWARE	\$1M
LIFESTYLE	HOME - GLASSWARE - PITCHERS/DECANTERS	\$1M
LIFESTYLE	HOME - GLASSWARE & BAR	\$1M
LIFESTYLE	HOME - KITCHEN ACCESSORIES & UTENSILS	\$1M
LIFESTYLE	HOME - LAMPS & LIGHTING	\$1M
LIFESTYLE	HOME - MATTRESSES (non-baby)	\$1M
LIFESTYLE	HOME - OUTDOOR FURNITURE (non-baby & non-electric)	\$1M
LIFESTYLE	HOME - SERVEWARE - OUTDOOR	\$1M
LIFESTYLE	HOME - SERVEWARE - TEA POTS & CUPS	\$1M

LIFESTYLE	HOME - SERVEWARE - TEA/COFFEE ACCESSORIES	\$1M
LIFESTYLE	HOME - SERVEWEAR	\$1M
LIFESTYLE	HOME - SMALL APPLIANCES & UTENSILS	\$1M
LIFESTYLE	HOME - SMALL DECOR ITEMS (non-elec)	\$1M
LIFESTYLE	HOME - STORAGE & ORGANIZATION	\$1M
LIFESTYLE	HOME - TABLE LINENS	\$1M
LIFESTYLE	HOME - TABLEWARE/ CUTLERY (non-elec)	\$1M
LIFESTYLE	HOME - TOWELS & LINENS	\$1M
LIFESTYLE	HOUSEWARES (electric)	\$1M
LIFESTYLE	JEWELLERY (excluding infant & kids)	\$1M
LIFESTYLE	JEWELLERY ORGANIZERS	\$1M
LIFESTYLE	MUGS	\$1M
LIFESTYLE	MUGS - TRAVEL	\$1M
LIFESTYLE	PET - APPAREL	\$1M
LIFESTYLE	PET - TOYS & ACCESSORIES	\$1M
LIFESTYLE	SMALL ACCESSORIES - KEYCHAINS	\$1M
LIFESTYLE	SUMMER - BEACH TOWELS & OUTDOOR BLANKETS	\$1M
LIFESTYLE	TRAVEL ACCESSORIES (Ex. LUGGAGE TAGS, PACKING CUBES, TRAVEL KITS, ETC.)	\$1M
LIFESTYLE	UMBRELLAS	\$1M
LIFESTYLE	WATER BOTTLES	\$1M
WELLNESS	CLEANING PRODUCTS	\$1M
WELLNESS	HEALTH & WELLNESS - HOT WATER BOTTLES	\$1M
WELLNESS	HEALTH, FITNESS & WELLNESS MONITORS	\$1M
WELLNESS	HOME - FRAGRANCE (non-candle, non-electric)	\$1M
WELLNESS	HOME - HUMIDIFIER (non-baby/kids)	\$1M

WELLNESS	PERSONAL CARE - FRAGRANCE/PERFUME (ADULT USE ONLY - non-medicinal)	\$1M
WELLNESS	PERSONAL CARE - HAIR - SHAMPOO/ HAIRCARE (ADULT USE ONLY - non-medicinal)	\$1M
WELLNESS	PERSONAL CARE - LIP CARE (ADULT USE ONLY - non-medicinal)	\$1M
WELLNESS	PERSONAL CARE - LOTIONS/OILS (ADULT USE ONLY - non-medicinal, no retinol, non-serums)	\$1M
WELLNESS	PERSONAL CARE - MAKEUP (ADULT USE ONLY - non-medicinal, no retinol, non-serums)	\$1M
WELLNESS	PERSONAL CARE - PRE-NATAL - LOTIONS/OILS (ADULT USE ONLY - non-medicinal)	\$1M
WELLNESS	PERSONAL CARE - SOAPS/BODYWASH/SALTS (ADULT USE ONLY - non-medicinal)	\$1M
WELLNESS	WELLNESS - FITNESS, YOGA, PILATES & MEDITATION ACCESSORIES	\$1M
WELLNESS	WELLNESS - FITNESS, YOGA, PILATES, MEDITATION EQUIPMENT	\$1M
ELECTRONICS	TECH - AUDIO	\$1M
ELECTRONICS	TECH - CHARGERS & CABLES	\$1M
ELECTRONICS	TECH - DRIVES/ STORAGE/ COMPUTER ACCESSORIES	\$1M
ELECTRONICS	TECH - eREADER CASES	\$1M
ELECTRONICS	TECH - eREADER LIGHTS	\$1M
ELECTRONICS	TECH - eREADERS	\$1M
ELECTRONICS	TECH - FITNESS BANDS, TRACKERS & WEARABLES	\$1M
ELECTRONICS	TECH - GAMING & ACCESSORIES	\$1M
ELECTRONICS	TECH - GAMING CONSOLE	\$1M
ELECTRONICS	TECH - HOME AUTOMATION	\$1M
ELECTRONICS	TECH - HOME NETWORKING	\$1M
ELECTRONICS	TECH - HOME SECURITY	\$1M
ELECTRONICS	TECH - HOME THEATRE	\$1M
ELECTRONICS	TECH - LAPTOPS	\$1M

ELECTRONICS	TECH - MEDIA PLAYER	\$1M
ELECTRONICS	TECH - MUSIC	\$1M
ELECTRONICS	TECH - PHONE CASES	\$1M
ELECTRONICS	TECH - SMART APPLIANCES	\$1M
GAMES/ADULT	ADULT - ART & CRAFT - FASHION, DESIGN KITS, SUPPLIES	\$1M
GAMES/ADULT	ADULT - ART & CRAFT KITS (Eg. ARTISTIC PAINTS & BRUSHES, SKETCHING & DRAWING, CALLIGRAPHY, EASELS)	\$1M
GAMES/ADULT	ADULT - ART & CRAFT KITS (Eg. KNITTING, NEEDLEPOINT, DIY KITS, ETC.)	\$1M
GAMES/ADULT	ADULT - GAMES - BOARDGAMES (battery operated)	\$1M
GAMES/ADULT	ADULT - GAMES - BOARDGAMES (non-battery operated)	\$1M
GAMES/ADULT	ADULT - GAMES - PUZZLES	\$1M
LIFESTYLE	GRILLING - BARBEQUE (PROPANE)	\$2M
LIFESTYLE	JEWELLERY - KIDS	\$2M
LIFESTYLE	OUTDOOR FIREPITS & HEATERS	\$2M
LIFESTYLE	PET - FOOD/TREATS	\$2M
GOURMET	BEVERAGE - SODAS, JUICES, HOT CHOCOLATE MIX, BOTTLED WATER, ETC.	\$2M
GOURMET	BEVERAGE - TEA/COFFEE & ACCOMPANIEMENTS	\$2M
GOURMET	FOOD/CONFECTIONERY	\$2M
WELLNESS	PERSONAL CARE - ORAL CARE	\$2M
WELLNESS	PERSONAL CARE & WELLNESS PRODUCTS (internal use)	\$2M
ELECTRONICS	TECH - KIDS - ELECTRONICS	\$2M
ELECTRONICS	TECH - KIDS AUDIO	\$2M
KIDS	KIDS - APPAREL, FOOTWEAR, COSTUMES, HAIR ACCESSORIES	\$2M
KIDS	KIDS - BAGS - KIDS BACKPACKS & LUNCH BAGS	\$2M
KIDS	KIDS - BAGS, BACKPACKS & LUNCH BAGS	\$2M
KIDS	KIDS - BATH, TOYS, ACCESSORIES	\$2M

KIDS	KIDS - BEDDING	\$2M
KIDS	KIDS - FURNITURE	\$2M
KIDS	KIDS - LUNCH CONTAINERS	\$2M
KIDS	KIDS - ROOM DÉCOR	\$2M
TOYS	KIDS - ART & CRAFT KITS	\$2M
TOYS	KIDS - ART & CRAFT SUPPLIES & ACCESSORIES	\$2M
TOYS	KIDS - DOLL FURNITURE	\$2M
TOYS	KIDS - EDUCATIONAL TOYS	\$2M
TOYS	KIDS - GAMES - BOARDGAMES	\$2M
TOYS	KIDS - GAMES - PUZZLES	\$2M
TOYS	KIDS - INDOOR ACTIVITIES	\$2M
TOYS	KIDS - LOOT BAG ITEMS/TOYS	\$2M
TOYS	KIDS - PRESCHOOL TOYS	\$2M
TOYS	KIDS - PRETEND PLAY	\$2M
TOYS	KIDS - TECH TOYS	\$2M
TOYS	KIDS - TOYS	\$2M
TOYS	KIDS - TOYS - DRESS-UP	\$2M
TOYS	KIDS CREATIVITY & KITS	\$2M
TOYS	MUSICAL INSTRUMENT	\$2M
TOYS	TOYS - COLLECTIBLES	\$2M
TOYS	TOYS - DOLL CLOTHING & ACCESSORIES	\$2M
TOYS	TOYS - DOLLHOUSES & PLAYSETS	\$2M
TOYS	TOYS - DOLLS	\$2M
TOYS	TOYS - FIGURINES	\$2M
TOYS	TOYS - OUTDOOR GAMES	\$2M
TOYS	TOYS - PLUSH	\$2M

TOYS	TOYS - PRESCHOOL	\$2M
TOYS	TOYS - REMOTE CONTROLLED/CARS (batteries)	\$2M
TOYS	TOYS - REMOTE CONTROLLED/DRONES (batteries)	\$2M
TOYS	TOYS - ROBOTICS (batteries)	\$2M
TOYS	TOYS - SCIENCE & DISCOVERY	\$2M
TOYS	TOYS - WOODEN	\$2M
BABY	BABY - NURSING & ACCESSORIES	\$5M
BABY	BABY - TOYS - EARLY DEVELOPMENT	\$5M
BABY	BABY - ACCESSORIES	\$5M
BABY	BABY - APPAREL, FOOTWEAR, HATS, HEADWARE, BIBS, COSTUMES, HAIR ACCESSORIES	\$5M
BABY	BABY - BATH TUBS & POTTIES	\$5M
BABY	BABY - BEDDING & ACCESSORIES	\$5M
BABY	BABY - BLANKETS	\$5M
BABY	BABY - CARRIERS & WRAPS	\$5M
BABY	BABY - CHANGE STATIONS & ACCESSORIES	\$5M
BABY	BABY - CRIBS/BASSINETS/CHANGE TABLES/GLIDERS/FURNITURE	\$5M
BABY	BABY - DIAPERS & ACCESSORIES	\$5M
BABY	BABY - FEEDING & DISHWARE	\$5M
BABY	BABY - FOOD PREPARATION & ACCESSORIES	\$5M
BABY	BABY - FRAMES (non-electric) & KEEPSAKE BOOKS	\$5M
BABY	BABY - GEAR - CAR SEATS & ACCESSORIES	\$5M
BABY	BABY - GEAR - PORTABLE BEDS & PLAYARDS	\$5M
BABY	BABY - GEAR - STROLLERS & ACCESSORIES	\$5M
BABY	BABY - HIGHCHAIRS, BOOSTERS, SEATS	\$5M
BABY	BABY - MATTRESSES	\$5M

BABY	BABY - NURSERY DÉCOR	\$5M
BABY	BABY - NURSING & ACCESSORIES	\$5M
BABY	BABY - PJS & SLEEPSACKS	\$5M
BABY	BABY - PLAYTIME & TOYS	\$5M
BABY	BABY - RIDE ON TOYS	\$5M
BABY	BABY - SAFETY - GATES & PROOFING	\$5M
BABY	BABY - SAFETY - MONITORS	\$5M
BABY	BABY - SHAMPOO, SOAPS, OILS, CREAMS	\$5M
BABY	BABY - SKINCARE & HEALTH	\$5M
BABY	BABY - SOUNDS MACHINES & NIGHTLIGHTS	\$5M
BABY	BABY - STEP STOOLS & POTTY CHAIRS	\$5M
BABY	BABY - SWIMWEAR & ACCESSORIES	\$5M
BABY	BABY - SWINGS/BOUNCERS/WALKERS/JUMPERS	\$5M
BABY	BABY - TEETHING & PACIFIERS	\$5M
BABY	BABY - TOWELS & WASHCLOTH	\$5M
BABY	BABY - TOYS - BATH	\$5M
BABY	BABY - TOYS - EARLY DEVELOPMENT	\$5M
BABY	BABY - TOYS - SENSORY	\$5M
BABY	BABY & TODDLER TOYS	\$5M
BABY	JEWELLERY - INFANT	\$5M
KIDS	KIDS - MEALTIME - UTENSILS, ACCESSORIES, WATER BOTTLES	\$5M
KIDS	KIDS - PROTECTIVE GEAR (excludig HELMETS (separate category))	\$5M
KIDS	KIDS - SHAMPOO, SOAPS, OILS, CREAMS	\$5M
KIDS	SPORTING GOODS - ACCESSORIES (non-protective)	\$5M
KIDS	SPORTS EQUIPMENT (INDOOR/OUTDOOR/GEAR/BIKES/SKATEBOARDS, ETC...)	\$5M

TOYS	KIDS - LARGE TOYS	\$5M
TOYS	KIDS - RIDE-ON TOYS/ BICYCLES/ TRICYCLES/ SCOOTERS/ SKATEBOARD/ SKATES	\$5M
TOYS	KIDS - SAND & WATER TOYS	\$5M
TOYS	POOL ACCESSORIES (NOODLES, INFLATABLES, FLOATIES, ETC...)	\$5M
TOYS	TOYS - OUTDOOR PLAY STRUCTURES (swing sets, large trampolines, large bouncers, etc...)	\$5M
TOYS	TOYS - SEASONAL	\$5M
TOYS	TOYS - SUMMER	\$5M
TOYS	TOYS - TENTS & TUNNELS	\$5M
TOYS	TOYS - VEHICLES	\$5M
TOYS	TOYS - WINTER OUTDOOR ACTIVITIES	\$5M
LIFESTYLE	ADULT - ELECTRIC SCOOTERS & BICYCLES	\$5M
KIDS	SAFETY GEAR (i.e. helmets,...)	\$10M
WELLNESS	SPECIALTY HEALTH & WELLNESS DEVICES (ie brain stimulation, etc...as required)	\$10M

FNF- OCEAN/AIR**FREIGHT NOTIFICATION FORM**

Ocean & Air Freight Requests to be completed by the Vendor **2 weeks** prior to shipping.
 Final consignee box must be checked off, along with final Destination Calgary or Toronto.

Please submit completed form as follows:

For International (Ocean & Air): IndigoGlobal@delmar.ca ; FAX: 905-206-9925

Date of Notification: _____

Vendor:	Consignee: (Please select one) <ul style="list-style-type: none"> <input type="checkbox"/> Indigo Books & Music Retail Distribution Centre 100 Alfred Kuehne Blvd Building # 55 Brampton, ON L6T4K4 <input type="checkbox"/> Indigo Books & Music Online Distribution Centre 100 Alfred Kuehne Blvd Building # 50 Brampton, ON L6T4K4 <input type="checkbox"/> Indigo Calgary Distribution Centre 5800-79 Avenue Southeast, Unit 10 Calgary, AB, T2C 4S6 Canada
Shipper (if different from Vendor): Contact: Telephone: Fax: Email:	Indigo P.O. Number(s): Final Destination: P.O. Completion Date: (Cargo ready date) PO Due Date into the Indigo DC: (date of delivery at Indigo)
Total Number of Pallets/Cases/Units: <input type="checkbox"/> Palletized <input type="checkbox"/> Floor Loaded	Total Weight: _____ kg Shipment Volume: _____ m ³
Freight Terms: <input type="checkbox"/> EXW <input type="checkbox"/> FOB <input type="checkbox"/> FCA	Name of Origin Port/ Terminal: (if FOB/FCA)
Mode of Transport:	Equipment Required:
<input type="checkbox"/> Ocean LCL <input type="checkbox"/> Ocean FCL <input type="checkbox"/> Air	<input type="checkbox"/> 20' <input type="checkbox"/> 40' <input type="checkbox"/> 40' High Cube <input type="checkbox"/> 45' <input type="checkbox"/> Special Equipment

Commodity Description/Special Handling:

IMPORTANT

This document is to be filled out by **ALL** Vendors shipping goods destined for Indigo Books & Music Inc. ("Indigo"). If the expected product completion date is not going to be met, it is the responsibility of the Vendor to advise the revised date as soon as possible.

For all shipments where **Indigo** is responsible for freight, shipments will be arranged by **Delmar International**.



INDIGO FREIGHT NOTIFICATION FORM

Date of Notification: _____	Ground Freight Requests to be completed by the Vendor 3 business days prior to shipping For Domestic & North America (Ground): IndigoNA@delmar.ca , Fax: 514.636.1212/ Tel: 514.636.8800				
Vendor Name and Address: *Must be completed	Consignee: *Please select one				
Hours of Operation: _____ Contact: _____ Telephone: _____ Fax: _____ Email: _____	<input type="checkbox"/> Indigo Books & Music Retail Distribution Centre 100 Alfred Kuehne Blvd Building # 55 Brampton, ON L6T4K4				
	<input type="checkbox"/> Indigo Books & Music Online Distribution Centre 100 Alfred Kuehne Blvd Building # 50 Brampton, ON L6T4K4				
	<input type="checkbox"/> Indigo Books & Music Distribution Centre - Calgary DC 5800 - 79 Avenue Southeast Unit 10 Calgary, AB T2C 4S6				
Shipper Name and Address: (If different from the Vendor) *Must be completed	PO#	Total #	Total	Total	Total
	Breakdown	Of Ctns	Units	Pallets	Weight
					(in lbs)
	Grand Total:				
Hours of Operation: _____ Contact: _____ Telephone: _____ Fax: _____ Email: _____	Date cargo available for pickup: _____				
	Carrier handover date: _____				
	PO due date into the Indigo DC: _____				
Special Instructions required ie. Straight truck required, residential, Hazmat with UN # and class please indicate.	Dimensions:				
	Pallet Height Requirement: Pallets cannot be taller than 52 inches in height unless pre-authorized by Indigo.				
	Commodity, description of goods:				
Please ensure the following is completed in full:					
An appointment is required for pick up: <input type="checkbox"/> Yes <input type="checkbox"/> No					
Is there a loading dock to pick up: <input type="checkbox"/> Yes <input type="checkbox"/> No					
Is a lift gate required to pick up: <input type="checkbox"/> Yes <input type="checkbox"/> No					

IMPORTANT

This document is to be filled out by **ALL** Vendors shipping goods destined for Indigo Books & Music Inc. ("Indigo"). If the expected product completion date is not going to be met, it is the responsibility of the Vendor to advise the revised date as soon as possible. For all shipments where Indigo is responsible for freight, shipments will be arranged by **Delmar International**. Should you not receive a response within 24 hrs of submitting please inquire by phone or email.



E

4 ALBERT EMBANKMENT
LONDON SE1 7SR
Telephone: +44 (0)20 7735 7611 Fax: +44 (0)20 7587 3210

MSC.1/Circ.1548
23 May 2016

**ADVICE TO ADMINISTRATIONS, PORT STATE CONTROL AUTHORITIES, COMPANIES,
PORT TERMINALS AND MASTERS REGARDING THE SOLAS REQUIREMENTS
FOR VERIFIED GROSS MASS OF PACKED CONTAINERS**

1 The Maritime Safety Committee, at its ninety-sixth session (11 to 20 May 2016), recalled that the amendments to SOLAS regulation VI/2, adopted by resolution MSC.380(94) and which will enter into force on 1 July 2016, introduce new paragraphs 4, 5 and 6 relating to the verification of the gross mass (VGM) of packed containers.

2 In this context, the Committee noted the concerns of Member States regarding practical aspects of compliance with the aforementioned SOLAS amendments, in particular, relating to transhipped containers and communication of VGM information, in an initial period following their entry into force.

3 The Committee agreed that Administrations and port State control authorities should adopt a practical and pragmatic approach when verifying compliance with the requirements of SOLAS regulations VI/2.4 to VI/2.6, for a period of three months after 1 July 2016, with a view to:

- .1 permitting packed containers that are loaded on a ship before 1 July 2016 and are transhipped on or after 1 July 2016 to be shipped to their final port of discharge without the VGM specified in SOLAS regulations VI/2.4 to VI/2.6; and
- .2 providing flexibility to all the stakeholders in containerized transport to refine, if necessary, procedures for documenting, communicating and sharing VGM information.

4 Notwithstanding the above, the Committee emphasized that the stability and safe operation of ships, including the safe packing, handling and transport of containers, is not limited to the provision and use of VGM information and is also covered by a number of SOLAS regulations, including SOLAS regulations VI/2.1, VI/2.2 and VI/2.3, and other IMO instruments, amongst others.

5 Member States are invited to be guided accordingly and to bring the contents of this circular to the attention of all concerned, especially port State control officers.

6 This circular will remain effective until 1 October 2016.

[https://edocs.imo.org/Final Documents/English/MSC.1-CIRC.1548 \(E\).docx](https://edocs.imo.org/Final Documents/English/MSC.1-CIRC.1548 (E).docx)



* Mandatory fields



SHIPPER VGM DECLARATION (LCL)

*Shipper/Manufacturer Company Name: *Address: *Authorized VGM contact: Phone: Fax: E-Mail:	*Submission date: *Signature of shipper's authorized contact:
---	--

*Seller (Defined as the name and address of the last known entity by whom the merchandise is sold or is agreed to be sold) *Address: Phone: Fax: Email:	Same as Manufacturer (Supplier)
---	---------------------------------

*Delmar Booking number:	*Delmar origin office: *Address: *Contact Person:
-------------------------	---

*Carrier booking number: Shipper invoice number: Shipper P/O number: Name of booked vessel: Voyage number: ETD / ETA:	Place of receipt: Port of Departure: Port of Discharge: Final Destination: Freight Terms:
--	---

Container number: Marks & numbers *No. & Kind of Pkg: Description of Goods:	*Verified Gross Mass (VGM) *In KG (Kilograms):
--	---

<input type="checkbox"/> For bookings of multiple container please complete and sign (Annex A)	
--	--

VGM evaluation method: (Please mark with "X")	<input type="checkbox"/> Method 1 (by weighing) After a shipment has been completely packed, the shipment can be weighed by regular equipment (Scales, fork lift scales, crane scales, etc.). Must meet national certification and calibration requirements. <input type="checkbox"/> Method 2 (by calculation)
---	--

All packages and cargo items may be weighted individually, incl. mass of dunnage, packing and securing material and added to Tare weight of the container (Tare weight for FCL shipment only).

The duly authorized contact person of the shipper hereby certifies, that the above mentioned shipment details are correct and consistent with the requirements of the International Convention for the Safety of Life at Sea (SOLAS), Chapter VI, part A Regulation 2. This Verified Gross Mass statement contains the VGM per container for FCL cargo or per shipment (for LCL cargo). Amendments, updates and/or corrections to the verified and declared weights have to be communicated and submitted to the responsible Delmar Ocean Freight department at least three days prior scheduled vessel departure.

Incorrect and/or belated VGM statements may result in non-acceptance of the shipment by the vessel operator and a delay in the originally planned schedule. Any additional cost caused by delay due to non-acceptance of the shipment by the carrier, will be at shipper's (VGM declaring party) expense.

© 2016 Delmar International Inc. All rights reserved.

SHIPPER

VGM DECLARAITON (LCL) | Page - 123 - of 143 | 05.20.2016 - v.01



* Mandatory fields

SHIPPER VGM DECLARATION (FCL)

*Shipper/Manufacturer Company Name:	*Submission date:
*Address:	*Signature of shipper's authorized contact:
*Authorized VGM contact:	
Phone:	
Fax:	
E-Mail:	

<p>*Seller (Defined as the name and address of the last known entity by whom the merchandise is sold or is agreed to be sold) *Address: Phone: Fax: Email:</p>	<input type="checkbox"/> Same as Manufacturer (Supplier)
*Delmar Booking number:	*Delmar origin office: *Address: *Contact Person:

*Carrier booking number: Shipper invoice number:	Place of receipt:
---	-------------------

Shipper P/O number: Name of booked vessel: Voyage number: ETD / ETA:	Port of Departure: Port of Discharge: Final Destination: Freight Terms:
Container number: Seal number (if applicable): *No. Of Container: Description of Goods:	*Verified Gross Mass (VGM) *In KG (Kilograms):
<input type="checkbox"/> For bookings of multiple container please complete and sign (Annex A)	
<p>VGM evaluation method: (Please mark with "X")</p> <p><input type="checkbox"/> Method 1 (by weighing) After a shipment has been completely packed, the shipment can be weighed by regular equipment (Scales, fork lift scales, crane scales, etc.). Must meet national certification and calibration requirements.</p> <p><input type="checkbox"/> Method 2 (by calculation) All packages and cargo items may be weighted individually, incl. mass of dunnage, packing and securing material and added to Tare weight of the container (Tare weight for FCL shipment only).</p>	

The duly authorized contact person of the shipper hereby certifies, that the above mentioned shipment details are correct and consistent with the requirements of the International Convention for the Safety of Life at Sea (SOLAS), Chapter VI, part A Regulation 2. This Verified Gross Mass statement contains the VGM per container for FCL cargo or per shipment (for LCL cargo). Amendments, updates and/or corrections to the verified and declared weights have to be communicated and submitted to the responsible Delmar Ocean Freight department at least three days prior scheduled vessel departure.

Incorrect and/or belated VGM statements may result in non-acceptance of the shipment by the vessel operator and a delay in the originally planned schedule. Any additional cost caused by delay due to non-acceptance of the shipment by the carrier, will be at shipper's (VGM declaring party) expense.

**SHIPPER VGM DECLARATION (FCL) ANNEX A
FOR BOOKINGS WITH MULTIPLE CONTAINERS**

Delmar Booking number:
Shipper name:
Shipper address:
Carrier booking number:
Vessel name:
Voyage number:
ETD:

Container #	Seal #	VGM (kg)	*Signature of shipper's authorized contact:
			Submission date:

CANADA CUSTOMS INVOICE – COMPLETION INSTRUCTIONS

Below is a brief description of how each required data field on the Canada Customs Invoice must be completed. The data field name as shown on the Canada Customs Invoice is in bold face, followed by some equivalent commercial terms in parenthesis.

- Field No. 1** Vendor (seller, sold by, remit to, consignor, shipper):
Must indicate the name and address of:
(a) the person selling the goods to the purchaser, or
(b) the person consigning the goods to Canada.
- Field No. 2** Date of Direct Shipment to Canada:
Must display the date on which the goods began their continuous journey to Canada.
- Field No. 3** Other References:
Enter the Purchase Order Number or an equivalent number that can easily be linked back to the order in your system.
- Field No. 4** Consignee (ship to, deliver to):
Must indicate the name and address of the person (company) in Canada to whom the goods are shipped.
- Field No. 5** Purchaser (if other than consignee) (sold to, buyer):
The person to whom the goods are sold by the vendor:
- Indigo Books & Music Inc.
100 Alfred Kuehne Blvd, Building #55
Brampton, Ontario
L6T 4K4, Canada
Business No.: 897152666-RM0001
- Field No. 6** Country of Transshipment:
The country through which the goods were shipped in transit to Canada under Customs control. If the shipment is from the USA indicate "n/a" in this field.
- Field No. 7** Country of Origin:
For Customs purposes, the country of origin of invoiced goods is the country where the goods are grown, produced or manufactured. The country of origin must be stated for each item on the invoice.
- Field No. 8** Transportation (Give Mode and Place of Direct Shipment to Canada)
Indicate the mode of transportation used and the place from which the goods began their uninterrupted journey to Canada. This field should also contain the statement "For Customs Clearance contact Indigo's appointed Freight Forwarder and Customs Broker"

- Field No. 9** Conditions of Sale and Terms of Payment:
Must describe the terms and the conditions agreed upon by the vendor and the purchaser [example: Free Carrier (FCA) Carriage Paid To (CPT), Carriage and Insurance Paid(CIP), Delivered Duty Paid (DDP), Delivered at Place (DAP), etc.].
- Field No. 10** Currency of Settlement
Indicate the currency in which the vendor's demand for payment is made.
- Form No. 11** Number of Packages:
Indicate the number of packages.
- Form No. 12** Specification of Commodities:
The following information must be provided:
(a) Kind of Packages — Indicate the nature of the packages (e.g., cases, etc.).
(b) General Description and Characteristics — Give in general terms, description of the merchandise (e.g. ceramic dinnerware, children's clothing, etc.).
(c) Commercial Description — Show a proper identifying description in commercial terms (i.e. enter the products item number).
(d) Harmonized System Classification Number – indicate the ten-digit Canadian or six-digit International classification.
- Field No. 13** Quantity:
The quantity of each item included in the description field must be indicated in the appropriate unit of measure.
- Field No. 14** Unit Price (price per article, item amount):
Must provide a value in the currency of settlement (as defined under Field 10) for each item described in the description field.
- Field No. 15** Total:
Indicate the price paid or payable in the currency of settlement (as defined under Field 10) for the number of items recorded in the quantity field when they were sold by the vendor to the purchaser. Where there is no price paid or payable for the items recorded in the description field, "n/a" should be indicated. Should "n/a" be indicated in this field the statement "Value for Customs purposes only \$_____" or "Value included in above invoice amount" must be shown.
- Field No. 16** Total Weight:
Show both net and gross weight.
- Field No. 17** Invoice Total (total value, pay this amount):
The total price paid or payable for goods described on the invoice and/or continuation sheet(s) if used. This field must reflect the actual value "price payable" of the transaction between the buyer and the vendor.

- Field No. 18** Commercial Invoice:
Enter the attached commercial invoice number if applicable.
- Field No. 19** Exporter (name and address), if other than vendor:
Indicate the name and address of the person or organization shipping the goods to the consignee/purchaser.
- Field No. 20** Originator (name and address):
Where the invoice is completed on behalf of a company, the name and address of the company must be indicated. The name of the person completing the invoice may also be indicated. This field may be left blank if this information is provided elsewhere on the invoice.
- Field No. 21** Departmental Ruling:
Give the number and date of any departmental ruling applicable to the shipment.
- Field No. 22** This field is to be checked off when the remaining fields 23-25 are not applicable.
- Field No. 23** This field is completed when the following are included in the invoice total (field 17):
- the cost of transportation of the loading, unloading and handling charges and other charges and expenses associated with the transportation from the place of direct shipment to Canada
 - the cost of insurance relating to the transportation of the goods from the place within the country of export from which the goods are shipped
 - costs, charges or expenses for the construction, erection, assembly, maintenance and technical assistance when incurred after the importation of the goods and are identified separately from the price paid or payable
 - export packing
- Field No. 24** This field is completed when the following are not included in the invoice total (field 17):
- the cost of transportation of the loading, unloading and handling charges and other charges and expenses associated with the transportation to the place of direct shipment to Canada
 - amounts for commissions other than buying commissions
 - packing costs and charges in respect of the goods and all expenses of packing incident to placing the goods in the condition in which they are shipped. Including the cost of cases and other containers and the cost of labour to the place of direct shipment to Canada
- Field No. 25** This field is to be completed (checked) where royalties and license fees including payments for patents, trade-marks and copyrights are applicable and/or when the purchaser has supplied goods or services for use in the production of these goods.

CANADA CUSTOMS INVOICE (SAMPLE ONLY)

Form can be found at: <http://www.cbsa.gc.ca/publications/forms-formulaires/ci1.pdf>

 Canada Border Services Agency / Agence des services frontaliers du Canada		CANADA CUSTOMS INVOICE FACTURE DES DOUANES CANADIENNES		PROTECTED PROTEGE		B when completed / une fois rempli	
1. Vendor (name and address) - Vendeur (nom et adresse)		2. Date of direct shipment to Canada - Date d'expédition directe vers le Canada		Page		of / de	
		yyyy/mm/dd					
4. Consignee (name and address) - Destinataire (nom et adresse)		3. Other references (Include purchaser's order No.) / Autres références (Inclure le n° de commande de l'acheteur)		5. Purchaser's name and address (if other than consignee) / Nom et adresse de l'acheteur (s'il diffère du destinataire)			
		6. Country of transshipment - Pays de transbordement		7. Country of origin of goods / Pays d'origine des marchandises		IF SHIPMENT INCLUDES GOODS OF DIFFERENT ORIGINS ENTER ORIGINS AGAINST ITEM IN 12. / SI L'EXPÉDITION COMPREND DES MARCHANDISES D'ORIGINES DIFFÉRENTES, PRÉCISEZ LEUR PROVENANCE EN 12.	
8. Transportation: Give mode and place of direct shipment to Canada / Transport: Précisez mode et point d'expédition directe vers le Canada		9. Conditions of sale and terms of payment (I.e. sale, consignment shipment, leased goods, etc.) / Conditions de vente et modalités de paiement (p. ex. vente, expédition en consignation, location de marchandises, etc.)		10. Currency of settlement - Devises du paiement			
11. Number of packages / Nombre de colis	12. Specification of commodities (kind of packages, marks and numbers, general description and characteristics, i.e., grade, quality) / Désignation des articles (nature des colis, marques et numéros, description générale et caractéristiques, p. ex. classe, qualité)	13. Quantity (state unit) / Quantité (précisez l'unité)	14. Unit price / Prix unitaire		15. Total		
18. If any of fields 1 to 17 are included on an attached commercial invoice, check this box / Si tout renseignement relativement aux zones 1 à 17 figure sur une ou des factures commerciales ci-attachées, cochez cette case		16. Total weight - Poids total		17. Invoice total / Total de la facture			
		Net		Gross - Brut			
19. Exporter's name and address (if other than vendor) / Nom et adresse de l'exportateur (s'il diffère du vendeur)		20. Originator (name and address) - Expéditeur d'origine (nom et adresse)					
21. Agency ruling (if applicable) - Décision de l'Agence (s'il y a lieu)		22. If fields 23 to 25 are not applicable, check this box / Si les zones 23 à 25 sont sans objet, cochez cette case					
23. If included in field 17 indicate amount: / Si compris dans le total à la zone 17, précisez:		24. If not included in field 17 indicate amount: / Si non compris dans le total à la zone 17, précisez:		25. Check (if applicable): / Cochez (s'il y a lieu):			
(i) Transportation charges, expenses and insurance from the place of direct shipment to Canada / Les frais de transport, dépenses et assurances à partir du point d'expédition directe vers le Canada		(i) Transportation charges, expenses and insurance to the place of direct shipment to Canada / Les frais de transport, dépenses et assurances jusqu'au point d'expédition directe vers le Canada		(i) Royalty payments or subsequent proceeds are paid or payable by the purchaser / Des redevances ou produits ont été ou seront versés par l'acheteur			
(ii) Costs for construction, erection and assembly incurred after importation into Canada / Les coûts de construction, d'érection et d'assemblage après importation au Canada		(ii) Amounts for commissions other than buying commissions / Les commissions autres que celles versées pour l'achat		(ii) The purchaser has supplied goods or services for use in the production of these goods / L'acheteur a fourni des marchandises ou des services pour la production de ces marchandises			
(iii) Export packing / Le coût de l'emballage d'exportation		(iii) Export packing / Le coût de l'emballage d'exportation					

CH1 (08/09) If you require more space, please attach another sheet. - Si vous avez besoin de plus d'espace, veuillez joindre une autre feuille. BSF189

COMPLETION INSTRUCTIONS – FORM A

In order for a Form A to be accepted by the CSCB, it must be properly completed, as follows:

- Field No. 1** Complete with the name, address, and country of the actual manufacturer or exporter of the goods. Please do not identify a trading house, freight forwarder, export broker, etc. The manufacturer or exporter must be located in the GPT or LDCT beneficiary country in which the goods are being certified.
- Field No. 2** Identify the consignee (name and address) in Canada.
- Field No. 3** The CSCB does not consider this a mandatory field, but you may indicate the shipping details, as far as known when Form A is completed.
- Field No. 4** This field is usually left blank. However, if Form A is issued after the goods have already been shipped, stamp or write "Issued Retrospectively."
- Field No. 5** This field is not mandatory for goods exported to Canada. It is usually used to itemize goods if Form A covers two or more categories of goods (for example, items 1, 2, 3 or items a, b, c).
- Field No. 6** If the goods are crated or otherwise packaged, indicate the quantity of packages or crates. Also indicate any markings on the crates that will be useful in cross-referencing Form A to the Through Bill of Lading so that the CSCB officers can establish that the form covers the goods that are physically imported.
- Field No. 7** Describe the goods fully. Indicate makes, models, styles, serial numbers, or any other relevant description. It is in the exporter's interest to give as full a description as possible. The CSCB will not accept a Form A that cannot be matched with the imported goods due to a vague description. It is also helpful to show the Harmonized System subheading of the goods in this field.
- Field No. 8** The origin criterion shown must be one of the following:
P means 100% of the goods produced in the GPT or LDCT beneficiary country in question;
F for GPT, means, at least 60% of the ex-factory price is produced in the GPT beneficiary country;
F for LDCT, means, at least 40% of the ex-factory price is produced in the LDCT beneficiary country. The existing 40% of the ex-factory price of the goods as packed for shipment to Canada may also include a value of up to 20% of the ex-factory price of the goods from countries eligible for GPT;
G for GPT, means at least 60% of the ex-factory price was cumulatively produced in more than one GPT beneficiary country or Canada;
G for LDCT, means at least 40% of the ex-factory price was cumulatively produced in more than one LDCT beneficiary country or Canada. The existing

40% of the ex-factory price of the goods as packed for shipment to Canada may also include a value of up to 20% of the ex-factory price of the goods from countries eligible for GPT.

If any criterion other than P, G, or F is shown for goods exported to Canada, it will be assumed that the goods do not satisfy the Canadian GPT or LDCT rules of origin and they will not receive any tariff preference.

- Field No. 9** Give the weight or other quantity of the goods. The best unit of measure to use when completing this field is the unit of measure given for the particular goods in the *Customs Tariff* (e.g. number, pairs, dozens, kilograms, litres).
- Field No. 10** Cross-reference Form A to the commercial invoice. This helps the CSCB match the form with the invoice, but it also ensures that the signing officer has verified the ex-factory price of the proper goods.
- Field No. 11** This field may be left blank. As of March 1, 1996, Canada no longer requires Form A to be certified by a designated authority in the GPT or LDCT beneficiary country.
- Field No. 12** This is the exporter's declaration that Form A is accurate and that the goods do meet the GPT or LDCT rules of origin. Proof of origin must be completed by the exporter of the goods in the GPT or LDCT beneficiary country in which the goods were finished. The individual completing the Form A on behalf of the company must be knowledgeable regarding the origin of the goods and have access to cost of production information, should verification be requested.

FORM A – CERTIFICATE OF ORIGIN

(SAMPLE ONLY)

1. Goods consigned from (Exporter's business name, address, country)			Reference No. GENERALIZED SYSTEM OF PREFERENCES CERTIFICATE OF ORIGIN (Combined declaration and certificate) FORM A Issued in (country) See the instructions.		
2. Goods consigned to (Consignee's name, address, country)					
3. Means of transport and route (as far as known)			4. For official use		
5. Item number	6. Marks and numbers of packages	7. Number and kind of packages: description of goods	8. Origin criterion (See instructions)	9. Gross weight or other quantity	10. Number and date of invoices.
11. Certification It is hereby certified, on the basis of control carried out, that the declaration by the exporter is correct. Place and date, signature and stamp of certifying authority.			12. Declaration by the exporter The undersigned hereby declares that the above details and statements are correct: that all the goods were produced in (country) and that they comply with the original requirements specified for those goods in the Generalized System of Preferences for goods exported to (importing country) Place and date, signature of authorized signatory		

APPLICATION FOR CERTIFICATE OF ORIGIN

Form B

The undersigned, being the exporter of the goods described overleaf, **DECLARES** that these goods were produced in (country)

SPECIFIES as follows the grounds on which the goods are claimed to comply with GSP origin requirements¹⁾

SUBMITS the following supporting documents²⁾

UNDERTAKES to submit, at the request of the appropriate authorities of the exporting country, any additional supporting evidence which these authorities may require for the purpose of issuing a certificate of origin, and undertakes, if required, to agree to any inspection of his accounts and any check on the processes of manufacture of the above goods, carried out by the said authorities.

REQUESTS the issue of a certificate of origin for these goods.

Place and date

┌
└

(signature of authorized signatory)

¹⁾ To be completed if materials or components originating in another country have been used in the manufacture of the goods in question. Indicate the materials or components used, their CCC Nomenclature tariff heading, their country of origin and, where appropriate, the manufacturing processes qualifying the goods as originating in the country of manufacture (application of List B or of the special conditions laid down in List A), the goods produced and their CCC Nomenclature tariff heading.

Where the origin criteria involve a percentage value, give information enabling this percentage to be verified – for example the value of imported materials and components and those of undetermined origin and the ex-factory price of the exported goods, where applicable.

²⁾ For example, import documents, invoices, etc. relating to the materials or components used.

NOTES

A. Procedure for claiming preference. A declaration on the certificate of origin form must be prepared by the exporter of the goods and submitted in duplicate, together with a GSP application form, to the certifying authority of the country of exportation which will, if satisfied, certify the top copy of the certificate of origin and return it to the exporter for transmission to the importer in the country of destination. The certifying authority will at the same time return to the exporter for his retention the duplicate copy of the certificate of origin, but will itself retain the GSP application form duly completed and signed by the exporter.

B. Sanctions. Persons who furnish, or cause to be furnished, information which relates to origin or consignment, and which is untrue in a material particular are liable to legal penalties and to the suspension of facilities for their goods to obtain preference.

CUSTOMS TARIFF – SCHEDULE

LIST OF COUNTRIES AND APPLICABLE TARIFF TREATMENTS

Please use the following link to access a list of the countries and territories that are designated as beneficiary countries for the purposes of the tariff treatments indicated. Tariff Treatment abbreviations are defined in Section 27 of the *Customs Tariff*.

<https://www.cbsa-asfc.gc.ca/trade-commerce/tariff-tarif/current-actuel-eng.html>

COMPLETION INSTRUCTIONS – NAFTA CERTIFICATE OF ORIGIN

Field 1 Exporter's name and address

Canadian exporters or Canadian producers shipping goods to the U.S. or Mexico - State the full legal name and address (including country and legal tax identification number) of the exporter. The number is the employer number or importer/exporter number that Canada Customs and Revenue Agency assigns.

U.S. exporters or U.S. producers shipping goods to Canada - State the legal name and address (including the country and legal tax identification number) of the exporter. The number is the employer identification number that the Internal Revenue Services of the U.S. Department of the Treasury assigns or, if applicable, the social security number.

Mexico exporters or Mexico producers shipping goods to Canada - State the legal name and address (including the country and legal tax identification number) of the exporter. The number is the federal taxpayer's registry number (RFC).

Field 2 Blanket period

A certificate can apply to:

- a single shipment of goods; or
- a multiple shipment of identical goods.

A certificate that covers multiple shipments is called a **blanket certificate**. Field 2 indicates the starting and ending dates of the blanket period for which certification is being made. The blanket period can last for two days to one year. It is acceptable to have a starting date that is before the date the certificate is signed. The importer can apply for a refund of the duty paid on goods entered on the certificate before the certificate is signed.

A blanket certificate certifies that all goods listed in field 5 of that document that are imported into Canada during the blanket period qualify as originating under the rules of origin, and that those goods are eligible for preferential tariff treatment.

When goods are imported into a bonded warehouse, it is the date they enter the warehouse that should be covered by the blanket period. The fact that accounting for the goods and claiming a NAFTA tariff treatment might not occur until sometime later does not affect the validity of the certificate, as long as the goods entered Canada within the blanket period.

Field 3 Producer's name and address

State the full legal name, address (including country), and legal tax identification number, as defined in field 1, of the person or company that produced the goods.

If the exporter is also the producer of the goods, enter "same."

If the certificate covers goods produced by more than one company, attach a list of the producers with the appropriate information. Cross-reference each producer with the goods they produced, as described in field 5.

If the exporter does not wish to disclose the identity of the producer to the importer, it is acceptable to state "available to customs on request."

If exporters do not know the identity of the producer of the goods, that usually means that they do not know the origin of the goods, and therefore should not be completing a *Certificate of Origin*. However, in rare instances, it is acceptable for the exporter to state that the producer is "unknown."

Field 4 Importer's name and address

State the full legal name, address (including country), and legal tax identification number (as defined in field 1) of the importer.

If there is more than one importer, state "various."

If the importer is unknown, state "unknown." This often applies when producers complete certificates for exporters.

Field 5 Description of good(s)

Provide a full description of each good covered by the certificate. List only goods that satisfy the NAFTA rules of origin.

The description must provide enough detail to relate the certificate to the imported goods and to the invoice. Model and serial numbers are not required, but they can be used as a cross-reference to the invoice and to differentiate between originating and non-originating goods.

It is in the exporter's interest to give as full a description as possible, since Canada Customs and Revenue Agency may not accept a certificate if it cannot match it to the imported goods because of a vague description.

Goods that fall under the same origin criterion but under different HS subheadings (or conversely under the same HS subheading but a different origin criterion) must be described separately.

If the certificate covers a single shipment of a good, include the invoice number as shown on the commercial invoice. If not known, indicate another unique reference number, such as the shipping order, purchase order, or letter of credit number.

When necessary, attach a separate listing on a continuation sheet to the certificate to provide a complete description of the good or goods.

Field 6 HS tariff classification number

For each good described, identify the HS tariff classification. For most goods, identifying the six-digit HS subheading is sufficient. For some goods, however, the specific rule of origin (from Annex 401 of the Agreement) requires a change at the eight-digit, tariff-item level. For these goods, identify the eight-digit tariff item of the importing country.

Field 7 Preference criteria

There are six preference criteria: A through F. Each of these preference criteria correspond to a category of rules of origin. Since each good described in field 5 of the certificate must be an originating good, they must each satisfy a rule of origin. The preference criterion is essentially a code which tells both the importer and Canada Customs and Revenue Agency which rule-of-origin category the goods satisfy. Consequently, exporters or producers who try to identify a preference criterion without familiarizing themselves with the rules of origin⁴ and applying them will have a difficult time choosing a criterion.

Criterion A corresponds to article 401(a) of the Agreement, which covers goods that are "wholly obtained or produced in one or more of Canada, Mexico, and the United States."

Wholly obtained or produced only refers to goods that were grown, mined, bred, fished, extracted, etc., from a NAFTA party. The goods must be 100% NAFTA origin to qualify under this criterion.

Simply because goods were purchased from a supplier in Canada, the U.S., or Mexico does not mean that they are wholly obtained within the meaning of criterion A.

Criterion B corresponds to article 401(b) of the Agreement, which covers goods that a producer makes using non-originating materials.⁵ The non-originating materials must meet the conditions set out in the specific rule of origin that applies, which can be found in Annex 401 of the Agreement.

The rules of origin ensure that any non-originating materials undergo enough processing before they can be transformed into a North American product. Most often, the rule of origin is expressed in terms of an HS classification change. This means that a non-originating material changes from one classification number in the HS to another.

When the material is incorporated into the final product, in some cases the rule of origin requires a certain percentage of the value of the goods, referred to as regional value content, to be incurred in North America in addition to the HS classification change. The rules in Annex 401 of the Agreement define exactly what must occur before the good can be considered as originating.

Criterion C corresponds to article 401(c) of the Agreement, which covers goods a producer makes using only originating materials. The difference between criteria A and C is that the originating materials used under criterion C can have some non-NAFTA content which has already been transformed by the producer's North American supplier into an originating material.

(Please note that criterion C does not necessarily mutually exclude criteria A, B, D, or E.)

Criterion D corresponds to article 401(d) of the Agreement, which covers goods where there is no change in tariff classification from non-originating materials to the finished good. However, since criterion D applies only in two very limited circumstances, its use is quite rare.

Please note that criterion D can **never** be used for wearing apparel provided for in chapters 61 and 62 of the HS, or for textile articles described in chapter 63.

The types of goods that can be considered as originating under criterion D are as follows:

- Goods which are complete except for being imported into the NAFTA territory in an unassembled or disassembled condition can be considered as originating. The unassembled or disassembled materials are classified in the same heading or subheading as the assembled good, and the heading or subheading cannot be further divided. The cost of assembling such goods in the NAFTA territory must satisfy a regional-value-content requirement.⁶ Please note that this rule is limited to unassembled goods in which all the materials for assembling the goods are included at the time the goods are imported into the NAFTA territory. If any additional materials must be added to the non-originating unassembled goods, the goods imported into Canada will not qualify for NAFTA. In reality, the application of this rule is extremely limited.
- When goods produced using non-originating materials that cannot undergo the required change because the non-originating materials are classified as "parts" in the HS under the same heading or subheading as the finished goods, and the heading or subheading is not further subdivided, these goods can be considered as originating. A regional-value-content condition must be satisfied.⁷

Criterion E applies only to certain automatic data-processing goods. These goods are specifically identified in Annex 308.1 of the Agreement (Table 308.1.1). Canada, the U.S., and Mexico have agreed to reduce the most-favoured-nation (MFN) duty rate for certain automatic data-processing equipment and parts falling into the categories listed below. Except for category (vi) below, the goods will have their MFN duty rates eliminated or reduced in five equal annual stages **starting January 1, 1999**. For category (vi) (computer parts of subheading No. 8473.30), the three parties reduced their MFN rate to free as of January 1, 1994.

The categories of goods covered under criterion E are:

- automatic data processing (ADP) machines;
- digital processing units;
- input or output units;
- storage units;
- other units of ADP (subheading No. 8471.90);
- parts of computers (subheading No. 8473.30); and
- computer power supplies.

Once the MFN duty rate has been reduced according to the staging schedule, and all three parties have arrived at the reduced rate, these goods will be considered as originating when traded among the three parties. Please note that under Canada Tariff, most of these goods are duty free under the most-favoured-nation.

Criterion F applies to bilateral trade agreements between NAFTA countries. One set of rules apply to U.S./Mexico trade, and another set of rules apply to Canada/Mexico trade. Criterion F is not relevant to Canada/U.S. trade.

Criterion F should not be used for goods exported from the U.S. to Canada. For goods exported from Mexico to Canada, exporters or producers should follow the instructions below.

When agricultural goods are imported into Canada, to complete field 7, the exporter or producer must first determine if they are originating goods under criteria A, B, or C (criteria D and E are not relevant to agricultural goods). Then, if the goods are wholly produced in Mexico or jointly produced Mexican/U.S. or Mexican/Canadian, it must be determined if the goods are qualifying goods within the meaning of Annex 703.2, section B, paragraph 14. Annex 703.2-B-14 says:

... **qualifying good** means an originating good that is an agricultural good except that, in determining whether such good is an originating good, operations performed in or material obtained from the United States shall be considered as if they were performed or obtained from a non-party. After the exporter or producer determines that the goods are originating and qualifying, they must determine if the goods are subject to any quantitative restrictions when imported into Canada. If no quantitative restrictions apply, the exporter or producer may use criterion F.

Field 8 Producer

In this field, the person completing the *Certificate of Origin* is telling Canada Customs and Revenue Agency why they have the information needed to substantiate the certificate.

If the exporter is the producer of the goods, state "yes."

If the exporter is not the producer, state "no," followed by one of three possible explanations why the exporter is in a position to certify the origin of the goods:

- "No(1)" if the origin of the goods was certified based on the exporter's knowledge of whether the goods qualify as originating;
- "No(2)" if the person signing the certificate is relying on written information from the producer (other than a *Certificate of Origin*) documenting that the goods qualify as originating; or
- "No(3)" if a completed and signed *Certificate of Origin* for the goods was provided to the exporter by the producer.

Whether or not an exporter can use "no(1)" will depend on the specific rule of origin. If the rule of origin requires only a tariff change, and the exporters know where the tariff change occurs, then they can use "no(1)." However, if the rule of origin involves a regional-value-content requirement, it is unlikely that the exporter will be able to substantiate the certificate without cost-of-production documentation from the producer.

If exporters cannot substantiate the origin of goods, they should not be completing a *Certificate of Origin*.

Field 9 Net cost

In this field, those completing the *Certificate of Origin* indicate whether or not they used the net cost method to determine the regional value content (RVC) of a good. If the rule of origin for the goods requires the RVC to be calculated, the exporter or producer can use two methods of calculation. One is the **transaction value method**, and the other is the **net cost method**. This field should be completed in all cases with one of the following:

- If the exporter or producer has used the net cost method to determine the RVC, they will indicate "NC."
- If the exporter or producer has used the transaction value method, they will indicate "no."
- If the rule of origin for the goods does not require the RVC to be calculated, they will indicate "no."

In some cases, when exporters or producers use the net cost method to calculate RVC, they are entitled to average certain costs over a period of time. If they have averaged costs, they should identify the starting and ending dates of the averaging period below the "NC" (e.g., "02/01/07 - 31/03/07").

Field 10 Country of origin

This field has different applications for each country.

If field 10 is not completed, neither the importer nor Canada Customs and Revenue Agency will know which of the different tariff treatments the goods are eligible to receive. In this case, Canada Customs and Revenue Agency will expect the importer to pay the highest applicable NAFTA duty rates.

For most goods imported into Canada, there are three NAFTA tariff treatments.

For originating agricultural and textile goods imported into Canada, the exporter or producer should indicate either "US" or "MX" in field 10. If there is some joint production of the agricultural or textile goods between the U.S. and Mexico, the exporter or producer must apply the *Determination of Country of Origin for the Purposes of Marking Goods Regulations* to determine whether the goods are Mexican or American.

For all other goods imported into Canada, the exporter or producer will indicate either "US," "MX," or "JNT" in field 10. "JNT" stands for joint production of goods between the U.S. and Mexico. Generally speaking, using "JNT" will result in the highest NAFTA duty rate being applied to the goods. However, some rules of origin essentially say that, if there is joint production between the U.S. and Mexico and the contribution of one of those countries is relatively insignificant, the exporter can claim that the goods originate in the country where most of the production occurred. When both the U.S. and Mexico contribute significantly to the production of the goods, the exporter must state "JNT" in field 10. When there is joint production of the goods between the U.S. and Mexico, the exporter or producer should see the *NAFTA Tariff Preference Regulations*, found in Canada Customs and Revenue Agency Memorandum D11-4-19, *Regulations Respecting the Determination of When Goods are Entitled to the Benefit of the United States Tariff or Mexico-United States Tariff*, to determine whether they should complete field 10 with "US," "MX," or "JNT."

Field 11 Certification

The exporter or producer completing the *Certificate of Origin* is strongly advised to **read the statements in field 11** before signing the certificate.

All the information in field 11 (which includes the signature area) must be completed.

In addition to being able to substantiate the origin of the goods, the person signing the certificate should be someone in the company who is entitled to sign legally binding documents on behalf of the exporter or producer. This is someone who has full knowledge of the origin of the goods, and who has access to the books and records that substantiate the claim. If the statements made in the certificate are untrue, the company could be liable for penalties.

Update: February 17, 2005 - <http://www.cbsa.gc.ca/publications/dm-md/d11/d11-4-5-eng.pdf>

General Preferential Tariff (GPT)

If the 60% ex-factory price is not satisfied, or is not supported by adequate documentation, the goods are not eligible for the GPT and a Form A should not be issued for such goods.

Least Developed Country Tariff (LDCT)

If the 40% ex-factory price is not satisfied, or is not supported by adequate documentation, the goods are not eligible for the LDCT and a Form A should not be issued for such goods.

NAFTA – CERTIFICATE OF ORIGIN (SAMPLE ONLY)

Form can be found at: <http://www.cbsa.gc.ca/publications/forms-formulaires/b232-eng.pdf>



NORTH AMERICAN FREE TRADE AGREEMENT

CERTIFICATE OF ORIGIN

(Instructions Attached)

Restore/Restaurer

Please print or type

1 Exporter's Name and Address: Tax Identification Number: ▶	2 Blanket Period: From <input type="text" value="DD - MM - YY"/> To <input type="text" value="DD - MM - YY"/>
3 Producer's Name and Address: Tax Identification Number: ▶	4 Importer's Name and Address: Tax Identification Number: ▶

5 Description of Good(s)	6 HS tariff Classification Number	7 Preference Criterion	8 Producer	9 Net Cost	10 Country of Origin

11 I certify that:

- the information on this document is true and accurate and I assume the responsibility for proving such representations. I understand that I am liable for any false statements or material omissions made on or in connection with this document;
- I agree to maintain, and present upon request, documentation necessary to support this Certificate, and to inform, in writing, all persons to whom the Certificate was given of any changes that would affect the accuracy or validity of this Certificate;
- the goods originated in the territory of one or more of the Parties, and comply with the origin requirements specified for those goods in the North American Free Trade Agreement, and unless specifically exempted in Article 411 or Annex 401, there has been no further production or any other operation outside the territories of the Parties; and
- this Certificate consists of pages, including all attachments.

Authorized Signature:		Company:	
Name:		Title:	
Date (dd-mm-yy)	Telephone:	Fax:	